



2024 | OCAK
FİYAT LİSTESİ





BİZ KİMİZ...

2007 yılında kurulan **Elizan Elektrik**, elektrik sektörüne sunduğu **1000'**den fazla ürün çeşidi ile üretici, ithalatçı, ihracatçı, distribütör ve toptancı firma olarak hizmet vermektedir. Ürün çeşitliliğini ve kalitesini ise müşteri odaklı çalışma stratejisiyle güçlendirmeye devam etmektedir.

Elektrik malzemeleri üretimi, ithalatı, dağıtımı ve toptan satışı konusunda **17 yıllık** tecrübeye sahip kadrosu ile hizmet veren Elizan Elektrik, her müşteriye özel çözümler sunmaktadır. Sadece üretim değil, elektrik malzemesi ithalatı ve ihracatı da yapan **Elizan Elektrik**, dünyanın dört bir yanına kaliteli hizmet sunma misyonu ile hareket etmektedir.





Verification No.: CEGW23040645764R

VERIFICATION OF EMC COMPLIANCE

Applicant: ELIZAN ELEKTRİK ENERJİ İNS TAAM TURİZ SAN TIC LTD STI.
Address of applicant: Elektrokent 2 | Merkezi 1471 Cad. No:49 ZIP:06105 Ostim / Ankara /TURKEY

Product Description: POWER FACTOR CORRECTION CAPACITOR
Model No.: EWC2300.2S, EWC2300.5, EWC4001.5, EWC2301.0, EWC4001.1, EWC2301.5, EWC2521.5, EWC2302.5, EWC4002.5, EWC2525.5, EWC2303, EWC2305.0, EWC4005.0, EWC2525.0, EWC2307.5, EWC4007.5, EWC2527.5, EWC2310, EWC4010, EWC2510, EWC4012.5, EWC2512.5, EWC4015, EWC2515, EWC4020, EWC2520, EWC4025, EWC2525, EWC4030, EWC2530

Trade Mark: EUROWEST
 Sufficient samples of the product have been tested and found to be in conformity with
Test Standard: EN IEC 61000-6-1:2019, EN IEC 61000-6-2:2019

As shown in the
Test Report Number(s): TEGW23040645764R
Date of issue: April 11, 2023
Date of expiry: April 10, 2028

Conclusion:
 This Verification of EMC Compliance has been granted to the applicant based on the results of the TCF, performed by Global Testing Services Co., Ltd. on the sample of the above-mentioned product in accordance with the provisions of the relevant specific standards and the Directive 2014/53/EU. The CE mark as shown below can be used, under the responsibility of the manufacturer, after completion of an EU Declaration of Conformity and compliance with all relevant EU Directives. The affixing of the CE marking presumes in addition that the conditions in annexes II and IV of the Directive are fulfilled.

Approved by Hermann Wocher For and on behalf of Global Testing Services Co., Ltd.

Global Testing Services Co., Ltd.
 E-mail: info@gts.com http://www.gts.com
 Floor 2nd, Building D1, No. 126, Shuang Road, Malang District, Shanghai, China

Copyright of this certificate is owned by Global Testing Services Co., Ltd and may not be reproduced or used in any form without the prior approval of the General Manager.

Verification No.: CEGW23032145191

VERIFICATION OF LVD & EMC COMPLIANCE

Applicant: ELIZAN ELEKTRİK ENERJİ İNS TAAM TURİZ SAN TIC LTD STI.
Address of applicant: Elektrokent 2 | Merkezi 1471 Cad. No:49 ZIP:06105 Ostim / Ankara /TURKEY

Product Description: CURRENT TRANSFORMER
Model No.: EWT-3S, EWT-70, EWT-120, EWT-210, EWT-310, EWT-470

Trade Mark: EUROWEST
 Sufficient samples of the product have been tested and found to be in conformity with
Test Standard: EN 61869-1:2009, EN 61869-2:2012

As shown in the
Test Report Number(s): TEGW23032145191
Date of issue: April 11, 2023
Date of expiry: April 10, 2028

Conclusion:
 This Verification of EMC Compliance has been granted to the applicant based on the results of the TCF, performed by Global Testing Services Co., Ltd. on the sample of the above-mentioned product in accordance with the provisions of the relevant specific standards and the Directive 2014/53/EU. The CE mark as shown below can be used, under the responsibility of the manufacturer, after completion of an EU Declaration of Conformity and compliance with all relevant EU Directives. The affixing of the CE marking presumes in addition that the conditions in annexes II and IV of the Directive are fulfilled.

Approved by Hermann Wocher For and on behalf of Global Testing Services Co., Ltd.

Global Testing Services Co., Ltd.
 E-mail: info@gts.com http://www.gts.com
 Floor 2nd, Building D1, No. 126, Shuang Road, Malang District, Shanghai, China

Copyright of this certificate is owned by Global Testing Services Co., Ltd and may not be reproduced or used in any form without the prior approval of the General Manager.

Verification No.: CLGW23040645763R

VERIFICATION OF LVD COMPLIANCE

Applicant: ELIZAN ELEKTRİK ENERJİ İNS TAAM TURİZ SAN TIC LTD STI.
Address of applicant: Elektrokent 2 | Merkezi 1471 Cad. No:49 ZIP:06105 Ostim / Ankara /TURKEY

Product Description: POWER FACTOR CORRECTION CAPACITOR
Model No.: EWC2300.2S, EWC2300.5, EWC4001.5, EWC2301.0, EWC4001.1, EWC2301.5, EWC2521.5, EWC2302.5, EWC4002.5, EWC2525.5, EWC2303, EWC2305.0, EWC4005.0, EWC2525.0, EWC2307.5, EWC4007.5, EWC2527.5, EWC2310, EWC4010, EWC2510, EWC4012.5, EWC2512.5, EWC4015, EWC2515, EWC4020, EWC2520, EWC4025, EWC2525, EWC4030, EWC2530

Trade Mark: EUROWEST
 Sufficient samples of the product have been tested and found to be in conformity with
Test Standard: EN 60831-1:2014-AC:2014, EN 60831-2:2014

As shown in the
Test Report Number(s): TLGW23040645763R
Date of issue: April 11, 2023
Date of expiry: April 10, 2028

Conclusion:
 This Verification of LVD Compliance has been granted to the applicant based on the results of the TCF, performed by Global Testing Services Co., Ltd. on the sample of the above-mentioned product in accordance with the provisions of the relevant specific standards and the Directive 2014/35/EU. The CE mark as shown below can be used, under the responsibility of the manufacturer, after completion of an EU Declaration of Conformity and compliance with all relevant EU Directives. The affixing of the CE marking presumes in addition that the conditions in annexes II and IV of the Directive are fulfilled.

Approved by Hermann Wocher For and on behalf of Global Testing Services Co., Ltd.

Global Testing Services Co., Ltd.
 E-mail: info@gts.com http://www.gts.com
 Floor 2nd, Building D1, No. 126, Shuang Road, Malang District, Shanghai, China

Copyright of this certificate is owned by Global Testing Services Co., Ltd and may not be reproduced or used in any form without the prior approval of the General Manager.

Verification No.: CLJZ22110742268R

VERIFICATION OF LVD COMPLIANCE

Applicant: ELIZAN ELEKTRİK ENERJİ İNS TAAM TURİZ SAN TIC LTD STI
Address of applicant: Elektrokent 2 | Merkezi 1471 Cad. No:49 ZIP:06105 Ostim / Ankara /TURKEY

Trade Mark: EUROWEST
Product Description: SURGE PROTECTOR
Model No.: EP-D10, EP-D20, EP-C40, EP-C40, EP-12.5B+C, EP-B+C/S0, EP-100B, EP-100B-C/275V/320V, 1P, 2P, 3P, 4P, 1+1NPE, 3+NPE, 1+1T2, T2), EP-C40P/600V, 1000V, 1500V DC, 1+1T2, T2), EP10RS485/0V, 12V, 15V, 24V, 30V, 48V, 60V, 120V DC), EP-GS-100/275V/320V, 1P, 2P, 3P, 4P, 1+NPE, 3+NPE, 1+1T2+T3)

Sufficient samples of the product have been tested and found to be in conformity with
Test Standard: IEC 61643-11:2011, IEC 61643-31:2018

As shown in the
Test Report Number(s): TLJZ22110742268R
Date of issue: November 08, 2022
Date of expiry: November 07, 2027

Conclusion:
 This Verification of LVD Compliance has been granted to the applicant based on the results of the TCF, performed by Global Testing Services Co., Ltd. on the sample of the above-mentioned product in accordance with the provisions of the relevant specific standards and the Directive 2014/35/EU. The CE mark as shown below can be used, under the responsibility of the manufacturer, after completion of an EU Declaration of Conformity and compliance with all relevant EU Directives. The affixing of the CE marking presumes in addition that the conditions in annexes I, II and IV of the Directive are fulfilled.

Approved by Hermann Wocher For and on behalf of Global Testing Services Co., Ltd.

Global Testing Services Co., Ltd.
 E-mail: info@gts.com http://www.gts.com
 Floor 2nd, Building D1, No. 126, Shuang Road, Malang District, Shanghai, China

Copyright of this certificate is owned by Global Testing Services Co., Ltd and may not be reproduced or used in any form without the prior approval of the General Manager.

Verification No.: CEZJ22110742268R

VERIFICATION OF EMC COMPLIANCE

Applicant: ELIZAN ELEKTRİK ENERJİ İNS TAAM TURİZ SAN TIC LTD STI
Address of applicant: Elektrokent 2 | Merkezi 1471 Cad. No:49 ZIP:06105 Ostim / Ankara /TURKEY

Trade Mark: EUROWEST
Product Description: SURGE PROTECTOR
Model No.: EP-D10, EP-D20, EP-C40, EP-12.5B+C, EP-B+C/S0, EP-100B, EP-100B-C/275V/320V, 1P, 2P, 3P, 4P, 1+NPE, 3+NPE, 1+1T2, T2), EP-C40P/600V, 1000V, 1500V DC, 1+1T2, T2), EP10RS485/0V, 12V, 15V, 24V, 30V, 48V, 60V, 120V DC), EP-GS-100/275V/320V, 1P, 2P, 3P, 4P, 1+NPE, 3+NPE, 1+1T2+T3)

Sufficient samples of the product have been tested and found to be in conformity with
Test Standard: EN IEC 61000-6-1:2019, EN IEC 61000-9:2021, EN IEC 61000-3-2:2019+A1:2021, EN 61000-3-3:2013+A2:2021

As shown in the
Test Report Number(s): TLJZ22110742268R
Date of issue: November 08, 2022
Date of expiry: November 07, 2027

Conclusion:
 This Verification of EMC Compliance has been granted to the applicant based on the results of the TCF, performed by Global Testing Services Co., Ltd. on the sample of the above-mentioned product in accordance with the provisions of the relevant specific standards and the Directive 2014/53/EU. The CE mark as shown below can be used, under the responsibility of the manufacturer, after completion of an EU Declaration of Conformity and compliance with all relevant EU Directives. The affixing of the CE marking presumes in addition that the conditions in annexes I, II and IV of the Directive are fulfilled.

Approved by Hermann Wocher For and on behalf of Global Testing Services Co., Ltd.

Global Testing Services Co., Ltd.
 E-mail: info@gts.com http://www.gts.com
 Floor 2nd, Building D1, No. 126, Shuang Road, Malang District, Shanghai, China

Copyright of this certificate is owned by Global Testing Services Co., Ltd and may not be reproduced or used in any form without the prior approval of the General Manager.

Verification No.: CLGW2303234530S

VERIFICATION OF LVD COMPLIANCE

Applicant: ELIZAN ELEKTRİK ENERJİ İNS TAAM TURİZ SAN TIC LTD STI
Address of applicant: Elektrokent 2 | Merkezi 1471 Cad. No:49 ZIP:06105 Ostim / Ankara /TURKEY

Trade Mark: EUROWEST
Product Description: Earth Leakage Relay
Model No.: EKAR1-A, EKAR2-LC

Sufficient samples of the product have been tested and found to be in conformity with
Test Standard: EN 60947-2:2017+A1:2020

As shown in the
Test Report Number(s): TLGW2303234530S
Date of issue: April 10th, 2023
Date of expiry: April 09th, 2028

Conclusion:
 This Verification of LVD Compliance has been granted to the applicant based on the results of the TCF, performed by Global Testing Services Co., Ltd. on the sample of the above-mentioned product in accordance with the provisions of the relevant specific standards and the Directive 2014/35/EU. The CE mark as shown below can be used, under the responsibility of the manufacturer, after completion of an EU Declaration of Conformity and compliance with all relevant EU Directives. The affixing of the CE marking presumes in addition that the conditions in annexes II and IV of the Directive are fulfilled.

Approved by Hermann Wocher For and on behalf of Global Testing Services Co., Ltd.

Global Testing Services Co., Ltd.
 E-mail: info@gts.com http://www.gts.com
 Floor 2nd, Building D1, No. 126, Shuang Road, Malang District, Shanghai, China

Copyright of this certificate is owned by Global Testing Services Co., Ltd and may not be reproduced or used in any form without the prior approval of the General Manager.

Verification No.: CEGW2303234530E

VERIFICATION OF EMC COMPLIANCE

Applicant: ELIZAN ELEKTRİK ENERJİ İNS TAAM TURİZ SAN TIC LTD STI
Address of applicant: Elektrokent 2 | Merkezi 1471 Cad. No:49 ZIP:06105 Ostim / Ankara /TURKEY

Trade Mark: EUROWEST
Product Description: Earth Leakage Relay
Model No.: EKAR1-A, EKAR2-LC

Sufficient samples of the product have been tested and found to be in conformity with
Test Standard: EN 60947-2:2017+A1:2020

As shown in the
Test Report Number(s): TEGW2303234530E
Date of issue: April 10th, 2023
Date of expiry: April 09th, 2028

Conclusion:
 This Verification of EMC Compliance has been granted to the applicant based on the results of the TCF, performed by Global Testing Services Co., Ltd. on the sample of the above-mentioned product in accordance with the provisions of the relevant specific standards and the Directive 2014/53/EU. The CE mark as shown below can be used, under the responsibility of the manufacturer, after completion of an EU Declaration of Conformity and compliance with all relevant EU Directives. The affixing of the CE marking presumes in addition that the conditions in annexes II and IV of the Directive are fulfilled.

Approved by Hermann Wocher For and on behalf of Global Testing Services Co., Ltd.

Global Testing Services Co., Ltd.
 E-mail: info@gts.com http://www.gts.com
 Floor 2nd, Building D1, No. 126, Shuang Road, Malang District, Shanghai, China

Copyright of this certificate is owned by Global Testing Services Co., Ltd and may not be reproduced or used in any form without the prior approval of the General Manager.

AGNCERT BELGELENDİRME

UYGUNLUK SERTİFİKASI

ELİZAN ELEKT. ENERJİ İNŞ. TAAH. TURZ. SAN.TİC.LTD.ŞTİ.

VEDİKÖB MAH. MELİH GÖNÇEK BULV. NO:8316 YENİMAHALLE/ANKARA TÜRKİYE

Ürün: W/OTOMAT BARALARI
MODEL: 1 Faz 1 mm 9, 12, 18, 24, 30, 36 Modül
1 Faz 1.5 mm 12, 18, 24, 30, 36 Modül
1 Faz 2 mm 12, 18, 24, 30, 36 Modül
2 Faz 1 mm 6, 9, 12, 15, 20 Modül
2 Faz 1.5 mm 6, 9, 12, 15, 20 Modül
3 Faz 1 mm 2, 3, 4, 5, 6, 8, 10, 20 Modül
3 Faz 1.5 mm 4, 6, 8, 10, 20 Modül
4 Faz 2 mm 4, 6, 8, 10, 20 Modül
4 Faz 2.5 mm 4, 6, 8, 14 Modül

MARKA: EUROWEST

Agncert Standartlar / Direktifler / Yönetmelikler
TS EN 61439-1 Akçe güç anahtarları ve kontrol cihazları düzeni - Bölüm 1: Genel kurallar
TS EN 61439-2 Akçe güç anahtarları ve kontrol cihazları düzeni - Bölüm 2: Güç anahtarları ve kontrol cihazları

Sertifika No: 2023-01011
Tarih: 13 Eylül 2023

AGNCERT BELGELENDİRME

CERTIFICATE OF CONFORMITY

ELİZAN ELEKT. ENERJİ İNŞ. TAAH. TURZ. SAN.TİC.LTD.ŞTİ.

VEDİKÖB MAH. MELİH GÖNÇEK BULV. NO:8316 YENİMAHALLE/ANKARA TÜRKİYE

PRODUCT: W/ AUTOMAT SWITCHES
MODEL: 1 Phase 1 mm 9, 12, 18, 24, 30, 36 Modül
1 Phase 1.5 mm 12, 18, 24, 30, 36 Modül
1 Phase 2 mm 12, 18, 24, 30, 36 Modül
2 Phase 1 mm 6, 9, 12, 15, 20 Modül
2 Phase 1.5 mm 6, 9, 12, 15, 20 Modül
3 Phase 1 mm 2, 3, 4, 5, 6, 8, 10, 20 Modül
3 Phase 1.5 mm 4, 6, 8, 10, 20 Modül
4 Phase 2 mm 4, 6, 8, 10, 20 Modül
4 Phase 2.5 mm 4, 6, 14 Modül

TRADING MARK: EUROWEST

Related Standards / Directives / Regulations
TS EN 61439-1 Low-voltage switchgear and controlgear assemblies - Part 1: General rules
TS EN 61439-2 Low-voltage switchgear and controlgear assemblies - Part 2: Power switchgear and controlgear assemblies

Certification Ground
Technical File No: ELİZ-CE-001

Technical file provided by the manufacturer and reviewed along with the requirements of Low Voltage Directive (LVD) 2014/35/EU and related Turkish Law 2015/6532/27
Certification work related to the product
Preparation of EC Declaration of Conformity
CE-Marking on the Product

Certificate Number: AGN-TR-68072
Certificate Issue Date: 13 September 2023
Certificate Validity Date: 12 September 2025

SQR CERTIFICATION

SQR

Sertifika
CERTIFICATE

EUROWEST ELEKTRİK ENERJİ İTHALAT İHRACAT SAN. VE TİC. LTD. ŞTİ.

İVEDİK OSB MAHALLESİ MELİH GÖNÇEK BULVARI NO: 8317 YENİMAHALLE/ANKARA TÜRKİYE

ISO 9001:2015

Kapsam
ELEKTRİK MALZEMELERİ TOPTAN TİCARETİ (KABLO, SİĞORTA, DUY, FİS, PRİZ, AMPUL, ELEKTRİK ANAHTARI, DEVRE KESİCİ, SALTER, RÖLE, PİL, BATAKAYA V.B.) ENDÜSTRİYEL OLANAK İLE ELEKTRİK MAKİNE, ÇHAZ VE ALETLERDE KULLANILANLAR HARİC)

Değerlendirme Tarihi: 13 Eylül 2023

Yazın No: MTS-14811
Yazın Tarihi: 8.08.2019
Yazın No: MTS-14811
Yazın Tarihi: 8.08.2019
Yazın No: MTS-14811
Yazın Tarihi: 8.08.2019

SQR CERTIFICATION

SQR

Sertifika
CERTIFICATE

EUROWEST ELEKTRİK ENERJİ İTHALAT İHRACAT SAN. VE TİC. LTD. ŞTİ.

İVEDİK OSB MAHALLESİ MELİH GÖNÇEK BULVARI NO: 8317 YENİMAHALLE/ANKARA TÜRKİYE

ISO 10002:2018

Kapsam
ELEKTRİK MALZEMELERİ TOPTAN TİCARETİ (KABLO, SİĞORTA, DUY, FİS, PRİZ, AMPUL, ELEKTRİK ANAHTARI, DEVRE KESİCİ, SALTER, RÖLE, PİL, BATAKAYA V.B.) ENDÜSTRİYEL OLANAK İLE ELEKTRİK MAKİNE, ÇHAZ VE ALETLERDE KULLANILANLAR HARİC)

Değerlendirme Tarihi: 13 Eylül 2023

Yazın No: MTS-14814
Yazın Tarihi: 8.08.2019
Yazın No: MTS-14814
Yazın Tarihi: 8.08.2019
Yazın No: MTS-14814
Yazın Tarihi: 8.08.2019

SQR CERTIFICATION

SQR

Sertifika
CERTIFICATE

EUROWEST ELEKTRİK ENERJİ İTHALAT İHRACAT SAN. VE TİC. LTD. ŞTİ.

İVEDİK OSB MAHALLESİ MELİH GÖNÇEK BULVARI NO: 8317 YENİMAHALLE/ANKARA TÜRKİYE

ISO 14001:2015

Kapsam
ELEKTRİK MALZEMELERİ TOPTAN TİCARETİ (KABLO, SİĞORTA, DUY, FİS, PRİZ, AMPUL, ELEKTRİK ANAHTARI, DEVRE KESİCİ, SALTER, RÖLE, PİL, BATAKAYA V.B.) ENDÜSTRİYEL OLANAK İLE ELEKTRİK MAKİNE, ÇHAZ VE ALETLERDE KULLANILANLAR HARİC)

Değerlendirme Tarihi: 13 Eylül 2023

Yazın No: MTS-14812
Yazın Tarihi: 8.08.2019
Yazın No: MTS-14812
Yazın Tarihi: 8.08.2019
Yazın No: MTS-14812
Yazın Tarihi: 8.08.2019

SQR CERTIFICATION

SQR

Sertifika
CERTIFICATE

EUROWEST ELEKTRİK ENERJİ İTHALAT İHRACAT SAN. VE TİC. LTD. ŞTİ.

İVEDİK OSB MAHALLESİ MELİH GÖNÇEK BULVARI NO: 8317 YENİMAHALLE/ANKARA TÜRKİYE

OHSAS 18001:2007

Kapsam
ELEKTRİK MALZEMELERİ TOPTAN TİCARETİ (KABLO, SİĞORTA, DUY, FİS, PRİZ, AMPUL, ELEKTRİK ANAHTARI, DEVRE KESİCİ, SALTER, RÖLE, PİL, BATAKAYA V.B.) ENDÜSTRİYEL OLANAK İLE ELEKTRİK MAKİNE, ÇHAZ VE ALETLERDE KULLANILANLAR HARİC)

Değerlendirme Tarihi: 13 Eylül 2023

Yazın No: MTS-14813
Yazın Tarihi: 8.08.2019
Yazın No: MTS-14813
Yazın Tarihi: 8.08.2019
Yazın No: MTS-14813
Yazın Tarihi: 8.08.2019

KONDANSATÖRLER	SİLİNDİRİK TİP KONDANSATÖRLER 230V - 400V - 415V - 440V - 525V (50Hz)	07 - 09
TROİDLER	TOPRAK KAÇAK AKIM KORUMA RÖLELERİ	10
AC / DC PARAFUDRLAR	AC / DC PARAFUDRLAR	11 - 13
PLASTİK KABLO BAĞLARI	PLASTİK KABLO BAĞLARI BEYAZ PLASTİK KABLO BAĞLARI SİYAH ETİKETLİ KABLO BAĞLARI YAPIŞKANLI KROŞELER KABLO BAĞI ETİKET TAŞIYICI PANO ETİKET TAŞIYICI	14 - 17
İZOLELİ KABLO YÜKSÜKLERİ	İZOLELİ KABLO YÜKSÜKLERİ FRANSIZ NORMU / ALMAN NORMU ÇİFT GİRİŞLİ KABLO YÜKSÜKLERİ FRANSIZ NORMU / ALMAN NORMU	18 - 20
İZOLELİ KABLO TERMİNALLERİ	YUVARLAK TİP İZOLELİ KABLO UÇLARI ÇATAL TİP İZOLELİ KABLO UÇLARI EK MUFLARI İZOLELİ KABLO UÇLARI ERKEK / DIŞI TERMİNALLER İZOLELİ KABLO UÇLARI DIŞI FASTON TİP İZOLELİ KABLO UÇLARI TAM İZOLELİ DIŞI FASTON TİP KABLO UÇLARI İĞNE TİP İZOLELİ KABLO UÇLARI TAM İZOLELİ POLYAMİD BAYRAK TİP TERMİNALLER ERKEK / DIŞI GERİ DÖNÜŞÜMLÜ TERMİNALLER ERKEK FASTON TİP TERMİNALLER	21 - 25
MONOFAZE - TRİFAZE MÜŞTEREK W OTOMAT BARALARI / SIKMALI KABLO PAPUÇLARI	MONOFAZE MÜŞTEREK W OTOMAT BARALARI TRİFAZE MÜŞTEREK W OTOMAT BARALARI SIKMALI KABLO PAPUÇLARI EKO SERİ SIKMALI KABLO PAPUÇLARI STANDART SERİ MONTAJ RAYLARI RAY TAŞIYICI RAY TİPİ PANO PRİZLERİ AKSİYEL FANLAR ÇATI FANLARI (HIZLI BAĞLANTILI) PANO TERMOSTATLARI & HİGROSTAT PANO ISITICILAR	26 - 31
DAĞITICI ÜNİTELER	DAĞITICI ÜNİTELER	32 - 36
ÇOK AMAÇLI KLEMENSLER	GEÇMELİ BUAT KLEMENSLER ÇOK AMAÇLI KLEMENSLER	37
ISI İLE DARALAN MAKARONLAR / HALOJEN FREE ÇORAP ÇEŞİTLERİ	ISI İLE DARALAN SİYAH MAKARONLAR KABLO TOPLAMA ÇORABI	38 - 40
Ø22 BUTON VE LEDLİ SINYALLER	YAYLI BUTONLAR / LED IŞIKLI YAYLI BUTONLAR / KALICI - KAYICI / KALICI - KAYICI MANDAL BUTON LED IŞIKLI KALICI MANDAL BUTONLAR / ANAHTARLI KALICI BUTONLAR / Ø40 mm KAYICI MANTAR BUTONLAR / Ø40 mm KALICI (AÇIL STOP) MANTAR BUTONLAR / Ø40 mm KALICI LEDLİ (AÇIL STOP) MANTAR BUTONLAR / Ø40 mm KALICI MANTAR BUTONLAR / İKİZ BUTONLAR / Ø22 mm LED'Lİ SINYALLER / EA9S LED AMPULLER / Ø22 mm LED'Lİ VOLTMETRE / Ø22 mm LED'Lİ AMPERMETRE / Ø22 mm LED'Lİ VOLTMETRE & AMPERMETRE / Ø22 mm LED'Lİ BUZZER (90dB) / MOTORLU SİRENLER / Ø22 mm POTANSİYOMETRE TEK TURLU / BUTON AKSESUARLARI / BOŞ VE MONTAJLI KUMANDA KUTULARI / VİNÇ KUMANDA BUTONLARI (IP67) AYAK PEDALLARI T5 ANAHTARLI LED ARMATÜR ERİYEN BANTLAR / KABLO İŞARETLEME SİSTEMLERİ	41 - 53
PLASTİK GÖVDELİ LİMİT SWITCHLER MİKRO SWITCHLER	PLASTİK GÖVDELİ LİMİT SWITCHLER MİKRO SWITCHLER MİNİ KAPI SWITCHLERİ	54 - 62
MEKANİK VE HİDROLİK EL ALETLERİ	YÜKSÜK SIKMA PENSELERİ İZOLELİ VE İZOLELİSİZ KABLO PAPUCU SIKMA PENSESİ KABLO SIYIRMA PENSESİ KABLO PABUCU SIKMA PENSELERİ HİDROLİK KABLO PABUCU SIKMA PENSESİ KABLO KESME MAKASLARI 10x38 KARTUŞ SİGORTA YUVASI 10x38 PORSELEN SİGORTALAR KABLO RAKORLARI	63 - 67

SİLİNDİRİK TİP KONDANSATÖRLER 230V - 400V - 415V - 440V - 525V (50Hz)



AŞIRI BASINÇ KORUMA SİSTEMİ

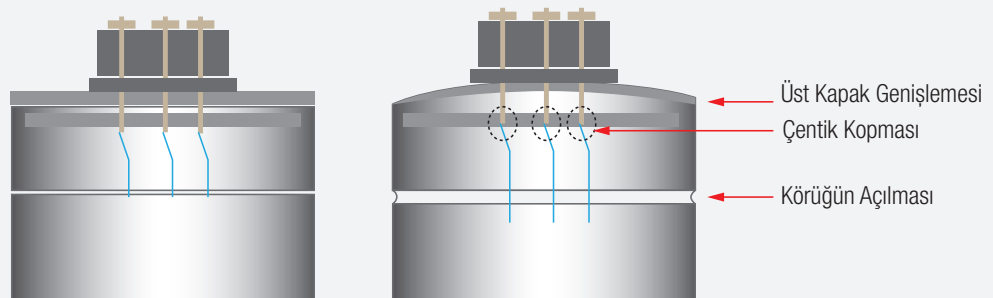

KONDANSATÖR TEKNİK ÖZELLİKLER

Standart	IEC 60831-1 & 2 IS : 13340
Tip	MKP Silindirik
Güç Aralığı (230V)	0.25 - 10 kVAr Tek Ünitede
Güç Aralığı (400V-415V-440V)	0.5 - 50 kVAr Tek Ünitede
Güç Aralığı (525V)	5 - 40 kVAr Tek Ünitede
Anma Gerilimi	230V-400V-415V-440V-525V-690V
Frekans	50 - 60 Hz
Maksimum Aşırı Gerilim U_{max}	Un + % 10 - 8 sa /24 sa Un + % 15 - 30 dk /24 sa Un + % 20 - 5 dk /24 sa Un + % 30 - 1 dk /24 sa
Dielektrik	Kendini onarabilen metalize edilen Polipropilen Film
Aşırı Akım	2xIn
Direnç Hariç Kayıplar	<0.2 Watt/kVAr
Direnç Hariç Kayıplar	<0.3 Watt/kVAr
Koruma Sınıfı	IP20
Soğutma	Doğal Soğutma
Maksimum Yükseklik	4000 metre
Kasa	Alüminyum Kasa / Silindirik
Deşarj	Dahili deşarj dirençli 50 V altına 60 s'de düşer.
Terminal	16 mm Kesatine Uygun Ark Korumalı Çift ve Üç Yönlü Terminal
Uygulama	Dahili
Kullanım Ömrü	50 °C 150.000 Saat (C Sınıfı) 55 °C 130.000 Saat (D Sınıfı)
Darbe Akımı	(200 - 400)xIr
Kapasite Toleransı	Alt yönde -%5 Üst yönde +%10
Test Gerilim Terminal-Terminal	2,15xUn, 10 s (Tip Test için) 2,15xUn, 2 s (Rutin Test için)
Test Gerilim Kasa - Terminal	3 kV, 1 dk (Tip Test için) 3 kV, 10s, min 2s (Rutin Test için)
Ortam Sıcaklığı	- 25 °C / 65 0C (D Sınıfı)
Montaj Pozisyonu	Yatay veya Dikey
Maksimum Nem	95%
Topraklama	M12 Civata ile
Koruma Özelliği	Aşırı basınçta açan kendini onarabilen
Emdirme	PCB içermeyen reçineli dolgu materyali

SİLİNDİRİK TİP KONDANSATÖR

230V 50Hz SİLİNDİRİK TİP MONOFAZE KONDANSATÖR

Ürün Kodu	Malzeme Tanımı	230V kVAr	400V kVAr	Ölçüler (DxH) (mm)	Akım (A)	Kapasitans (uF)	Koli Adeti	Liste Fiyatı Ad / TL
EWC230/0,25	MONOFAZE KONDANSATÖR 230V	0,25	0,76	35 x 107	1,09	15,05	30	452,00
EWC230/0,50	MONOFAZE KONDANSATÖR 230V	0,5	1,5	35 x 107	2,17	30,10	30	463,00
EWC230/1	MONOFAZE KONDANSATÖR 230V	1	3	40 x 140	4,35	60,20	30	549,00
EWC230/1,50	MONOFAZE KONDANSATÖR 230V	1,5	4,5	45 x 140	6,52	90,30	30	669,00
EWC230/2,50	MONOFAZE KONDANSATÖR 230V	2,5	9,6	57 x 160	10,87	150,50	30	986,00
EWC230/3	MONOFAZE KONDANSATÖR 230V	3	9,1	57 x 160	13,04	180,60	30	1.106,00
EWC230/5	MONOFAZE KONDANSATÖR 230V	5	15	63.5 x 170	21,74	301,00	12	1.909,00
EWC230/7,5	MONOFAZE KONDANSATÖR 230V	7,5	22,6	68 x 200	32,60	451,50	12	2.755,00
EWC230/10	MONOFAZE KONDANSATÖR 230V	10	30	85 x 210	43,47	602,00	12	3.535,00

400 / 415 / 440V 50Hz SİLİNDİRİK TİP TRİFAZE KONDANSATÖR

Ürün Kodu	Malzeme Tanımı	400V kVAr	415V kVAr	440V kVAr	Ölçüler (DxH) (mm)	Akım (A)	Kapasitans (uF)	Koli Adeti	Liste Fiyatı Ad / TL
EWC400/0,5	TRİFAZE KONDANSATÖR 400-415-440V	0,5	0,54	0,61	50 X 120	0,72	4,98	30	586,00
EWC400/1	TRİFAZE KONDANSATÖR 400-415-440V	1	1,08	1,21	50 X 120	1,44	9,95	30	595,00
EWC400/1,5	TRİFAZE KONDANSATÖR 400-415-440V	1,5	1,61	1,82	50 X 135	2,16	14,93	30	666,00
EWC400/2,5	TRİFAZE KONDANSATÖR 400-415-440V	2,5	2,69	3,03	50 X 135	3,6	24,88	30	792,00
EWC400/5	TRİFAZE KONDANSATÖR 400-415-440V	5	5,38	6,05	63.5 X 170	7,20	49,75	20	1.098,00
EWC400/7,5	TRİFAZE KONDANSATÖR 400-415-440V	7,5	8,07	9,08	63.5 X 200	10,80	74,63	20	1.489,00
EWC400/10	TRİFAZE KONDANSATÖR 400-415-440V	10	10,76	12,10	75 X 210	14,40	99,50	12	1.578,00
EWC400/12,5	TRİFAZE KONDANSATÖR 400-415-440V	12,5	13,46	15,13	75 X 210	18,00	124,38	12	1.912,00
EWC400/15	TRİFAZE KONDANSATÖR 400-415-440V	15	16,15	18,15	75 X 300	21,60	149,25	12	2.243,00
EWC400/20	TRİFAZE KONDANSATÖR 400-415-440V	20	21,53	24,20	85 X 300	28,80	199,00	8	3.086,00
EWC400/25	TRİFAZE KONDANSATÖR 400-415-440V	25	26,91	30,25	90 X 300	36,00	248,75	8	3.615,00
EWC400/30	TRİFAZE KONDANSATÖR 400-415-440V	30	32,29	36,30	100 X 300	43,2	298,50	6	4.026,00

525 / 480V 50Hz SİLİNDİRİK TİP TRİFAZE KONDANSATÖR

Ürün Kodu	Malzeme Tanımı	525V kVAr	480V kVAr	440V kVAr	Ölçüler (DxH) (mm)	Akım (A)	Kapasitans (uF)	Koli Adeti	Liste Fiyatı Ad / TL
EWC525/1,5	TRİFAZE KONDANSATÖR 525-480V	1,5	1,25	1,05	45 X 160	1,6485	8,655	30	960,00
EWC525/2,5	TRİFAZE KONDANSATÖR 525-480V	2,5	2,1	1,75	45 X 160	2,7	14,425	30	1.043,00
EWC525/5	TRİFAZE KONDANSATÖR 525-480V	5	4,2	3,51	57 X 160	5,5	28,85	20	1.475,00
EWC525/7,5	TRİFAZE KONDANSATÖR 525-480V	7,5	6,3	5,26	63.5 X 200	8,24	43,275	20	1.640,00
EWC525/10	TRİFAZE KONDANSATÖR 525-480V	10	8,36	7,02	75 X 210	10,99	57,7	12	1.875,00
EWC525/12,5	TRİFAZE KONDANSATÖR 525-480V	12,5	10,45	8,78	75 X 210	13,74	72,13	12	2.343,00
EWC525/15	TRİFAZE KONDANSATÖR 525-480V	15	12,54	10,53	75 X 300	16,5	86,6	12	2.543,00
EWC525/20	TRİFAZE KONDANSATÖR 525-480V	20	16,72	14,04	85 X 300	22	115,40	8	3.203,00
EWC525/25	TRİFAZE KONDANSATÖR 525-480V	25	20,9	17,56	90 X 300	27,5	144,25	8	4.212,00
EWC525/30	TRİFAZE KONDANSATÖR 525-480V	30	25,1	21,07	100 X 300	33	173,10	6	4.672,00

TROİDLER - TOPRAK KAÇAK AKIM KORUMA ROLELERİ

TROİDLER - TOPRAK KAÇAK AKIM KORUMA ROLELERİ

Ürün Kodu	Malzeme Tanımı	Liste Fiyatı Ad / \$
EKAR2-LC	T.K.A.K. Rölesi (Ray Tipi-Dijital) 10mA-30A / 230V AC	162,60 \$
EKAR1-A	T.K.A.K. Rölesi (Ray Tipi-Analog) 30mA-30A / 230V AC	94,20 \$
EWT-35	Ø35mm Kapalı Tip Toroid Akım Trafosu	28,00 \$
EWT-70	Ø70mm Kapalı Tip Toroid Akım Trafosu	38,12 \$
EWT-120	Ø120mm Kapalı Tip Toroid Akım Trafosu	81,85 \$
EWT-210	Ø210mm Kapalı Tip Toroid Akım Trafosu	145,75 \$
EWT-310	Ø310mm Kapalı Tip Toroid Akım Trafosu	334,00 \$
EWT-470	460x160mm Kapalı Tip Toroid Akım Trafosu	1.900,00 \$



MODEL	EKAR2-LC	EKAR1-A
Display	LCD display (Actual value of Leakage Current) With back light	Bargraph (% of set point)
Auxiliary Supply	90-270V AC/DC	
Burden On Supply	<3 VA	
Set Point (IΔn)	A-(0-999mA) 1 0A-(1 -9.99A) 30A-(10-30A) Pre- Alarm: 50-90% of Leakage current setting	0.03, 0.1, 0.3, 0.5, 1.0, 3.0, 5.0, 10.0, 20.0 & 30.0 Amps
Delay	Power ON Delay: 0-99.9 sec Trip Time Delay: 0-99.9 sec Recovery Time Delay: 0-99.9 SeC (Auto Reset)	0 (< 25mS for Fault current >5xIth), 60, 150, 250, 500, 800 msec, 1, 2, 5, 10, Sec
Relay Contacts	2 Potential free contact (NO, C & NC) (energise or de-energise on trip programmable)	1 Potential free contact (NO, C & NC) (Energise on trip)
Reset	Auto / Manual programme	Manual
Trip Relay	10mA - 30 Amps	80 - 90% of Set point
Alarm Relay (Optional)	50-90% of Trip Setting	50% of Set Value
Contact Rating	5 Amps / 230VAC / 28VDC	
Temperature	Operating: -10°C to 70°C, Storage: -20°C to 70°C	
Humidity	Up to 95% RH	
Dimensions	93x35x68 mm(LxBxH)	Refer diagram E on page no. 22
Input	CBCT 35/70/120/210 mm ID	
Special Features	Password Protection, Bargraph as % of set point, CBCT open circuit detection	CBCT open circuit detection

Earth Leakage Relay Accessory [CBCT]

Features

Compact, Reliable, Accurate, Flexible Design,
Detection of Earth Leakage Relay, Panel Mount

Current Transformer Type

Core Balance Current Transformer

Operating Range: 30 mA - 30A

Certification: CE



AC / DC PARAFUDRLAR

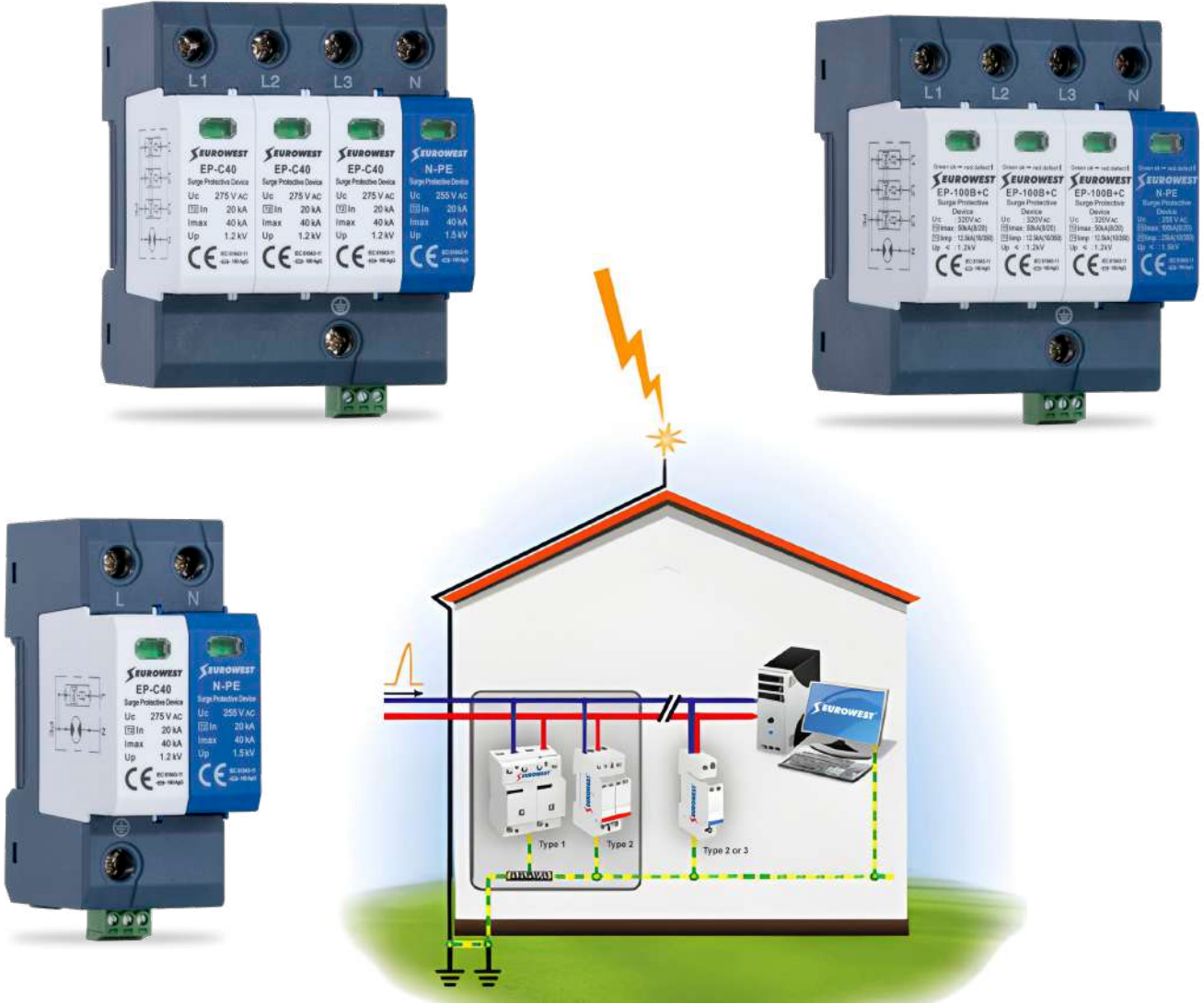

PARAFUDRLAR

- Tip 1+2 AC PARAFUDRLAR
- Tip 2 AC PARAFUDRLAR
- Tip 2+3 AC PARAFUDRLAR
- Tip 1+2 PV PARAFUDRLAR
- Tip 2 AC ve PV PARAFUDRLAR
- Tip 1+2+3 AC PARAFUDRLAR
- Tip 2&3 AC PARAFUDRLAR

TELEKOM SİSTEMLERİ KORUMA PARAFUDRLARI

- TEK DIN MODÜL

DATA SİNYAL VE RF KOAKSİYEL KORUMA

- DATA SİNYAL KORUMA
- RF KOAKSİYEL KORUMA



AC/DC AG PARAFUDRLAR

Birim Fiyat \$ / Adet	19,75 \$
Ürün Kodu	EP-D10/1P
Açıklama	T3, Uc: 320V, Imax: 10kA



Birim Fiyat \$ / Adet	34,45 \$
Ürün Kodu	EP-D10/1+1
Açıklama	T3, Uc: 320V, Imax: 10kA



Birim Fiyat \$ / Adet	20,80 \$
Ürün Kodu	EP-D20/1P
Açıklama	T3, Uc: 275V, In: 10kA, Imax: 20kA



Birim Fiyat \$ / Adet	68,10 \$
Ürün Kodu	EP-D20/3+1
Açıklama	T3, Uc: 275V, In: 10kA, Imax: 20kA



Birim Fiyat \$ / Adet	38,10 \$
Ürün Kodu	EP-C40/1+1
Açıklama	T2, Uc: 275V, In: 20kA, Imax: 40kA



Birim Fiyat \$ / Adet	81,00 \$
Ürün Kodu	EP-C40/3+1
Açıklama	T2, Uc: 275V, In: 20kA, Imax: 40kA



Birim Fiyat \$ / Adet	65,95 \$
Ürün Kodu	EP-12.5/B+C/1+1
Açıklama	T1+T2, Uc:275V, In: 20kA, Imax: 50kA, limp: 12.5kA



Birim Fiyat \$ / Adet	68,40 \$
Ürün Kodu	EP-B+C/50/1+1
Açıklama	T1+T2, Uc: 280V, In: 30kA, Imax: 50kA, limp: 12.5kA

AC/DC AG PARAFUDRLAR



Birim Fiyat \$ / Adet	200,00 \$
Ürün Kodu	EP-100B/3+1
Açıklama	T1, Uc: 280V, In: 60kA, Imax: 100kA, Iimp: 12.5kA



Birim Fiyat \$ / Adet	71,50 \$
Ürün Kodu	EP-C40 DC 3P 1000V
Açıklama	T2, Uc: 1000V, DC In: 20kA, Imax: 40kA



Birim Fiyat \$ / Adet	140,00 \$
Ürün Kodu	EP-GS-100/3+1
Açıklama	T1+T2+T3, Uc: 320V, In: 30kA, Imax: 100kA, Iimp: 8kA



Birim Fiyat \$ / Adet	77,50 \$
Ürün Kodu	EP-C40 DC 3P 1500V
Açıklama	T2, Uc: 1500V, DC In: 20kA, Imax: 40kA



Birim Fiyat \$ / Adet	135,00 \$
Ürün Kodu	EP-100B+C/3+1
Açıklama	T1+T2, Uc: 320V, Imax: 100kA, Iimp: 25kA



Birim Fiyat \$ / Adet	125,00 \$
Ürün Kodu	EP-C40PV 1000V
Açıklama	T1+T2, Uc: 1000V, In: 20kA, Imax: 40kA, Iimp: 6.25kA



Birim Fiyat \$ / Adet	53,25 \$
Ürün Kodu	EP-C40 DC 2P 1000V
Açıklama	T2, Uc: 1000V, DC In: 20kA, Imax: 40kA



Birim Fiyat \$ / Adet	128,00 \$
Ürün Kodu	EP-C40PV 1500V
Açıklama	T1+T2, Uc: 1500V, In: 20kA, Imax: 40kA, Iimp: 6.25kA

PLASTİK KABLO BAĞLARI

Malzeme naylon 66 ham maddesinden imal edilmiş olup, -40, +85 C° ortam sıcaklığında çalışır. UL 94/v2 normunda, kendini söndürme özelliğine sahiptir. Yüksek kaliteli CT Kablo Bağları (benzin, mazot, hayvansal yağ, boya, vernik) gibi maddelere karşı üstün direnç göstermektedir.



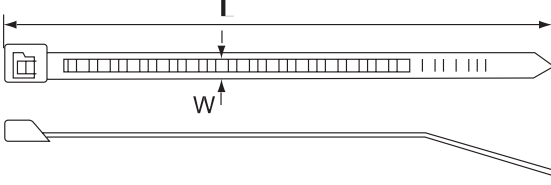

PLASTİK KABLO BAĞLARI BEYAZ

Ürün Kodu	Uzunluk (mm)	En (mm)	Renk	Maksimum Sıkma Çapı (mm)	Açılma Mukavemeti (kg)	Paket	Koli	Birim Fiyat TL / Adet
EW 100 M	100	2,5	Beyaz	18	8.1	1.000	70.000	0,22
EW 150 M	150		Beyaz	35		1.000	55.000	0,34
EW 200 M	200		Beyaz	50		1.000	32.000	0,48
EW 150 I	150	3.6	Beyaz	35	18	100	30.000	0,57
EW 200 I	200		Beyaz	50		100	20.000	0,75
EW 250 I	250		Beyaz	65		100	20.000	0,91
EW 300 I	300		Beyaz	76		100	17.000	1,15
EW 370 I	370		Beyaz	102		100	12.000	1,45
EW 200 S	200	4.8	Beyaz	50	22	100	16.000	1,06
EW 250 S	250		Beyaz	60		100	12.000	1,30
EW 300 S	300		Beyaz	76		100	11.000	1,59
EW 370 S	370		Beyaz	102		100	9.000	1,83
EW 430 S	430		Beyaz	110		100	7.500	2,45
EW 550 S	530		Beyaz	140		100	5.000	3,41
EW 300 H	300	7.6	Beyaz	76	55	100	5.000	3,25
EW 370 H	370		Beyaz	102		100	4.000	3,55
EW 450 H	430		Beyaz	110		100	2.500	4,15
EW 550 H	530		Beyaz	140		100	2.000	5,40
EW 720 HD	710	9	Beyaz	190	80	100	2.000	8,90
EW 800 HD	780		Beyaz	228		100	2.000	11,00
EW 920 HD	920		Beyaz	280		100	1.000	12,50
EW 1020 HD	1020		Beyaz	295		100	1.000	13,00
EW 1220 HD	1220		Beyaz	375		100	1.000	16,20



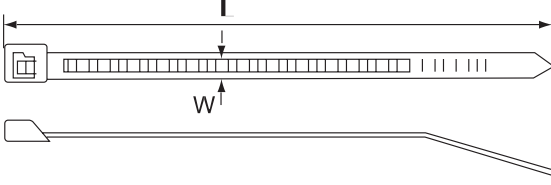

PLASTİK KABLO BAĞLARI SİYAH

Ürün Kodu	Uzunluk (mm)	En (mm)	Renk	Maksimum Sıkma Çapı (mm)	Açılma Mukavemeti (kg)	Paket	Koli	Birim Fiyat TL / Adet
EW 100 MB	100	2,5	Siyah	18	8.1	1.000	70.000	0,22
EW 150 MB	150		Siyah	35		1.000	55.000	0,34
EW 200 MB	200		Siyah	50		1.000	32.000	0,48
EW 150 IB	150	3.6	Siyah	35	18	100	30.000	0,57
EW 200 IB	200		Siyah	50		100	20.000	0,75
EW 250 IB	250		Siyah	65		100	20.000	0,91
EW 300 IB	300		Siyah	76		100	17.000	1,15
EW 370 IB	370		Siyah	102		100	12.000	1,45
EW 200 SB	200	4.8	Siyah	50	22	100	16.000	1,06
EW 250 SB	250		Siyah	60		100	12.000	1,30
EW 300 SB	300		Siyah	76		100	11.000	1,59
EW 370 SB	370		Siyah	102		100	9.000	1,83
EW 430 SB	430		Siyah	110		100	7.500	2,45
EW 550 SB	530		Siyah	140		100	5.000	3,41
EW 300 HB	300	7.6	Siyah	76	55	100	5.000	3,25
EW 370 HB	370		Siyah	102		100	4.000	3,55
EW 450 HB	430		Siyah	110		100	2.500	4,15
EW 550 HB	530		Siyah	140		100	2.000	5,40
EW 720 HDB	710	9	Siyah	190	80	100	2.000	8,90
EW 800 HDB	780		Siyah	228		100	2.000	11,00
EW 920 HDB	920		Siyah	280		100	1.000	12,50
EW 1020 HDB	1020		Siyah	295		100	1.000	13,00
EW 1220 HDB	1220		Siyah	375		100	1.000	16,20





ETİKETLİ KABLO BAĞLARI

Ürün Kodu	Uzunluk (mm)	En (mm)	Renk	Bağlama Çapı (mm)	Açılma Mukavemeti (kg)	Paket	Koli	Fiyat TL (adet)
EWK 100	100	2.5	Beyaz	20	8	100	30.000	0.71
EWK 200	190	4.8	Beyaz	48	22	100	12.000	1.70



YAPIŞKANLI KROŞELER

Ürün Kodu	Boyutlar					Renk	Ambalaj Adet		Birim Fiyat TL / Adet
	A	B	C	D	H		Paket	Koli	
EWY 1	19	19	3,6	Ø 3.2	4,0	Beyaz	100	20,000	1,00
EWY 2	28	28	4,8	Ø 3.2	4,5	Beyaz	100	9,000	1,78



KABLO BAĞI ETİKET TAŞIYICI

Ürün Kodu	Boyutlar			Etiket Eni (mm)	Etiket Boyu (mm)	Renk	Ambalaj Adet		Birim Fiyat TL / Adet
	A	B	C				Paket	Koli	
EWY - 1	35	10	8	32	7	Beyaz	100	8,000	1,75
EWY - 2	45	20	8	42	17	Beyaz	100	4,000	3,05



PANO ETİKET TAŞIYICI

Ürün Kodu	Boyutlar		Etiket Eni (mm)	Etiket Boyu (mm)	Renk	Ambalaj Adet		Birim Fiyat TL / Adet
	A	B				Paket	Koli	
EWPE - 1	30	17	27,5	14,4	Siyah	100	8,000	2,05
EWPE - 2	50	17	49	15	Siyah	50	5,000	2,70
EWPE - 3	75	17	72	15	Siyah	25	3,000	3,70



İZOLELİ KABLO YÜKSÜKLERİ

İZOLELİ KABLO TERMİNALLERİ







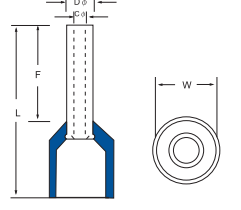









Standart : DIN 46228
 Malzeme : Bakır, Kalay Kaplama
 İzolasyon : Naylon
 Çalışma Sıcaklığı: Max. 105°C 600 Volt



İZOLELİ KABLO YÜKSÜKLERİ FRANSIZ NORMU







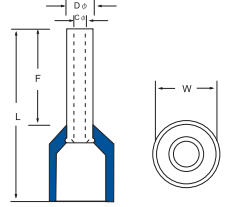





Ürün Kodu	Ebatlar (mm)					Renk	Kutu Adedi	Birim Fiyat TL / Adet
	F	L	W	B	C			
ERF - 0.50	8	14	2,6	6,0	1,3	 Beyaz	1.000	0,29
ERF - 0.75	8	14	2,8	6,3	1,5	 Mavi	1.000	0,29
ERF - 1.0	8	14	3,0	6,3	1,7	 Kırmızı	1.000	0,29
ERF - 1.5	8	14	3,5	6,3	2,0	 Siyah	1.000	0,32
ERF - 2.5	8	14	4,2	7,4	2,5	 Gri	500	0,41
ERF - 4.0	10	17	4,8	7,4	3,2	 Turuncu	500	0,69
ERF - 6.0	12	20	6,3	8,5	3,9	 Yeşil	250	0,93
ERF - 10.0	12	22	7,6	8,8	4,9	 Kahve	100	1,18
ERF - 16.0	12	24	8,8	10,0	6,2	 Bej	100	1,64
ERF - 25.0	16	28	11,2	12,0	7,7	 Siyah	50	2,75
ERF - 35.0	16	30	12,7	14,0	8,7	 Kırmızı	50	3,42
ERF - 50.0	20	36	15,0	16,0	10,9	 Mavi	25	6,48
ERF - 70.0	21	37	16,0	17,0	14,3	 Sarı	25	12,00



Standart : DIN 46228
 Malzeme : Bakır, Kalay Kaplama
 İzolasyon : Naylon
 Çalışma Sıcaklığı: Max. 105°C 600 Volt



İZOLELİ KABLO YÜKSÜKLERİ ALMAN NORMU

Ürün Kodu	Ebatlar (mm)					Renk	Kutu Adedi	Birim Fiyat TL / Adet
	F	L	W	B	C			
ERA - 0.50	8	14	2,6	6,0	1,3	 Turuncu	1.000	0,29
ERA - 0.75	8	14	2,8	6,3	1,5	 Beyaz	1.000	0,29
ERA - 1.0	8	14	3,0	6,3	1,7	 Sarı	1.000	0,29
ERA - 1.5	8	14	3,5	6,3	2,0	 Kırmızı	1.000	0,32
ERA - 2.5	8	14	4,2	7,4	2,5	 Mavi	500	0,41
ERA - 4.0	10	17	4,8	7,4	3,2	 Gri	500	0,69
ERA - 6.0	12	20	6,3	8,5	3,9	 Siyah	250	0,93
ERA - 10.0	12	22	7,6	8,8	4,9	 Bej	100	1,18
ERA - 16.0	12	24	8,8	10,0	6,2	 Yeşil	100	1,64
ERA - 25.0	16	28	11,2	12,0	7,7	 Kahve	50	2,75
ERA - 35.0	16	30	12,7	14,0	8,7	 Bej	50	3,42
ERA - 50.0	20	36	15,0	16,0	10,9	 Yeşil	25	6,48





Standart : DIN 46228
 Malzeme : Bakır, Kalay Kaplama
 İzolasyon : Naylon
 Çalışma Sıcaklığı : Max. 105°C 600 Volt

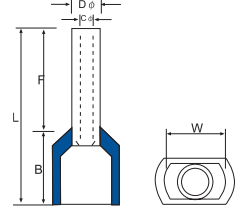

ÇİFT GİRİŞLİ KABLO YÜKSÜKLERİ FRANSIZ NORMU

Ürün Kodu	Ebatlar (mm)					Renk	Kutu Adedi	Birim Fiyat TL / Adet
	F	L	W	B	C			
DRF - 0.50	8	14	5,0	6,5	1,8	Beyaz	1.000	0,52
DRF - 0.75	8	14	5,5	6,7	2,1	Mavi	500	0,55
DRF - 1.0	8	14	5,5	7,1	2,4	Kırmızı	500	0,59
DRF - 1.5	8	14	6,4	7,5	2,6	Siyah	500	0,71
DRF - 2.5	17	14	8,0	8,5	3,3	Gri	250	1,14
DRF - 4.0	12	17	8,0	11,1	4,2	Turuncu	200	1,32
DRF - 6.0	14	20	9,5	12,1	5,3	Yeşil	100	1,64
DRF - 10.0	14	27	12,6	12,6	6,9	Kahve	50	2,52
DRF - 16.0	14	31	19,0	17,3	8,7	Bej	50	3,20



Standart : DIN 46228
 Malzeme : Bakır, Kalay Kaplama
 İzolasyon : Naylon
 Çalışma Sıcaklığı : Max. 105°C 600 Volt

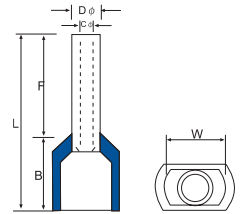

ÇİFT GİRİŞLİ KABLO YÜKSÜKLERİ ALMAN NORMU

Ürün Kodu	Ebatlar (mm)					Renk	Kutu Adedi	Birim Fiyat TL / Adet
	F	L	W	B	C			
DRA - 0.50	8	14	5,0	6,5	1,8	Turuncu	1.000	0,52
DRA - 0.75	8	14	5,5	6,7	2,1	Beyaz	500	0,55
DRA - 1.0	8	14	5,5	7,1	2,4	Sarı	500	0,59
DRA - 1.5	8	14	6,4	7,5	2,6	Kırmızı	500	0,71
DRA - 2.5	10	14	8,0	8,5	3,3	Mavi	250	1,14
DRA - 4.0	12	17	8,0	11,1	4,2	Gri	200	1,32
DRA - 6.0	14	20	9,5	12,1	5,3	Siyah	100	1,64
DRA - 10.0	14	27	12,6	12,6	6,9	Bej	50	2,52
DRA - 16.0	14	31	19,0	17,3	8,7	Yeşil	50	3,20





Standart : DIN 46228
 Malzeme : Bakır, Kalay Kaplama
 İzolasyon : Naylon
 Çalışma Sıcaklığı : Max. 105°C 600 Volt

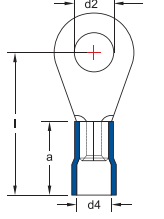

YUVARLAK TİP İZOLELİ KABLO UÇLARI

Ürün Kodu	Kablo Kesiti	Civata Ölçüsü	Ölçüler				Kutu Adedi	Kutulu B. Fiyat TL / Adet
			d2	l	d4	a		
● ERU - 301	0,5 - 1,5 mm ²	M3	3,2	16,0	4,0	10,0	200	0,94
● ERU - 401		M4	4,3	17,0	4,0	10,0	200	1,40
● ERU - 501		M5	5,3	18,0	4,0	10,0	200	1,42
● ERU - 601		M6	6,5	18,0	4,0	10,0	200	2,25
● ERU - 801		M8	8,4	22,0	4,0	10,0	200	2,25
● ERU - 302	1,5 - 2,50 mm ²	M3	3,2	16,0	4,5	10,0	200	1,74
● ERU - 402		M4	4,3	17,0	4,5	10,0	200	1,74
● ERU - 502		M5	5,3	17,0	4,5	10,0	200	1,76
● ERU - 602		M6	6,5	19,0	4,5	10,0	200	2,50
● ERU - 802		M8	8,4	21,0	4,5	10,0	200	2,50
● ERU - 1002		M10	10,5	22,0	4,5	10,0	200	2,60
● ERU - 406	4,0 - 6,0 mm ²	M4	4,3	22,0	4,5	10,0	100	3,70
● ERU - 506		M5	5,3	21,0	6,3	13,0	100	3,70
● ERU - 606		M6	6,5	22,0	6,3	13,0	100	4,20
● ERU - 806		M8	8,4	22,5	6,3	13,0	100	5,40
● ERU - 1006		M10	10,5	26,0	6,3	13,0	100	5,45
● ERU - 1206		M12	10,5	28,0	6,3	13,0	100	5,55
● ERU - 610	8,0 - 10,0 mm ²	M6	13,0	28,0	6,3	11,0	50	6,00
● ERU - 810		M8	6,7	30,0	8,0	17,0	50	7,50





Standart : DIN 46237
 Malzeme : Bakır, Kalay Kaplama
 İzolasyon : PVC
 Çalışma Sıcaklığı : Max. 105°C 600 Volt

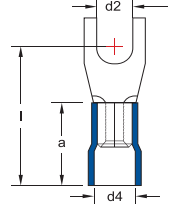

ÇATAL TİP İZOLELİ KABLO UÇLARI

Ürün Kodu	Kablo Kesiti	Civata Ölçüsü	Ölçüler				Kutu Adedi	Kutulu B. Fiyat TL / Adet
			d2	l	d4	a		
● ECU - 3001	0,50 - 1,50 mm ²	M3	3,2	16,0	4,0	10,0	200	1,28
● ECU - 4001		M4	4,3	17,0	4,0	10,0	200	1,32
● ECU - 5001		M5	5,3	18,0	4,0	10,0	200	1,38
● ECU - 6001		M6	6,5	20,0	4,0	10,0	200	1,56
● ECU - 3002	1,50 - 2,50 mm ²	M3	3,2	18,0	4,5	10,0	200	1,44
● ECU - 4002		M4	4,3	19,0	4,5	10,0	200	1,48
● ECU - 5002		M5	5,3	18,0	4,5	10,0	200	1,50
● ECU - 6002		M6	6,5	20,0	4,5	10,0	200	2,00
● ECU - 4006	4,0 - 6,0 mm ²	M4	4,3	22,0	4,5	13,0	100	3,25
● ECU - 5006		M5	5,3	22,0	4,5	13,0	100	3,30
● ECU - 6006		M6	6,5	25,0	4,5	13,0	100	4,40
● ECU - 8006		M8	8,4	21,5	6,3	13,0	100	5,15



Standart : DIN 46237
 Malzeme : Bakır, Kalay Kaplama
 İzolasyon : PVC
 Çalışma Sıcaklığı : Max. 105°C 600 Volt

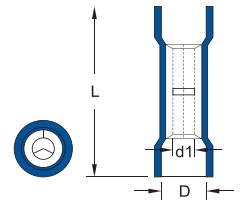

EK MUFLARI İZOLELİ KABLO UÇLARI

Ürün Kodu	Kablo Kesiti	Ölçüler			Kutu Adedi	Kutulu B. Fiyat TL / Adet
		L	D	d1		
● EBY - 251	0,50 - 1,50 mm ²	24,6	4,0	1,7	200	2,00
● EBY - 252	1,50 - 2,50 mm ²	24,6	4,5	2,3	200	2,00
● EBY - 256	4,00 - 6,00 mm ²	26,5	6,3	3,4	100	3,40



Malzeme : Pirinç, Kalay Kaplı, Bakır Yüksüklü
 İzolasyon : PVC
 Çalışma Sıcaklığı: Max. 75°C 300 Volt

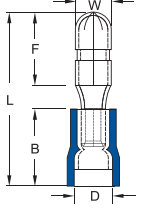

ERKEK TERMİNALLER İZOLELİ KABLO UÇLARI

Ürün Kodu	Kablo Kesiti	Ölçüler					Kutu Adedi	Kutulu B. Fiyat TL / Adet
		W	F	L	B	D		
● ERE - 1040	0,50 - 1,50 mm ²	4,0	8,5	21,5	10,5	3,8	100	3,30
● ERE - 2050	1,50 - 2,50 mm ²	5,0	8,5	21,5	10,5	4,7	100	3,80
● ERE - 5050	4,00 - 6,00 mm ²	5,0	8,5	24,0	13,0	6,2	100	5,10



Malzeme : Pirinç, Kalay Kaplı, Bakır Yüksüklü
 İzolasyon : PVC
 Çalışma Sıcaklığı: Max. 75°C 300 Volt

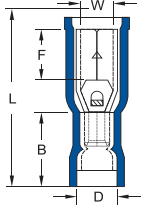

DIŞI TERMİNALLER İZOLELİ KABLO UÇLARI

Ürün Kodu	Kablo Kesiti	Ölçüler					Kutu Adedi	Kutulu B. Fiyat TL / Adet
		W	F	L	B	D		
● EBD - 1040	0,50 - 1,50 mm ²	3,9	7,0	23,3	10,5	3,8	100	4,00
● EBD - 2050	1,50 - 2,50 mm ²	4,9	7,0	23,3	10,5	4,7	100	4,50
● EBD - 5050	4,00 - 6,00 mm ²	4,9	7,0	25,1	12,5	6,2	100	5,60



Malzeme : Pirinç, Kalay Kaplama
 İzolasyon : PVC
 Çalışma Sıcaklığı: Max. 75°C 300 Volt

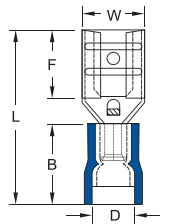

DIŞI FASTON TİP İZOLELİ KABLO UÇLARI

Ürün Kodu	Renk	Kablo Kesiti	Soket Genişliği	Ölçüler					Kutu Adedi	B. Fiyat TL / Adet
				W	F	L	B	D		
EFD - 1288	● Kırmızı	0,50-1,50 mm ²	0,8 x 2,80	3,2	6,5	19,0	10,5	3,8	200	0,89
EFD - 1488	● Kırmızı		0,8 x 4,75	5,0	6,4	19,4	10,5	3,8	200	1,15
EFD - 1638	● Kırmızı		0,8 x 6,35	6,6	7,5	20,8	10,5	3,8	200	1,47
EFD - 2288	● Mavi	1,50-2,50 mm ²	0,8 x 2,80	3,2	6,5	19,0	10,5	4,7	200	1,15
EFD - 2488	● Mavi		0,8 x 4,75	5,0	6,4	19,4	10,5	4,7	200	1,20
EFD - 2638	● Mavi		0,8 x 6,35	6,6	7,5	20,8	10,5	4,7	200	1,50
EFD - 5638	● Sarı	4,00 - 6,00 mm ²	0,8 x 6,35	6,6	7,5	23,3	13,0	6,2	200	1,70





Malzeme : Pirinç, Kalay Kaplama
 İzolasyon : PVC
 Çalışma Sıcaklığı : Max. 75°C 300 Volt

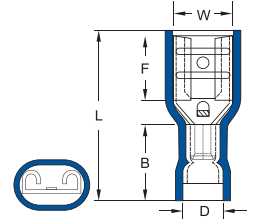

TAM İZOLELİ DİŞİ FASTON TİP KABLO UÇLARI

Ürün Kodu	Renk	Kablo Kesiti	Soket Geniřlięi	Ölçüler					Kutu Adedi	B. Fiyat TL / Adet
				W	F	L	B	D		
EFFD - 1288	● Kırmızı	0,50-1,50 mm ²	0,8 x 2,80	3,2	6,5	19,0	10,5	3,8	200	1,44
EFFD - 1488	● Kırmızı		0,8 x 4,75	5,0	6,4	20,5	10,5	3,8	200	1,70
EFFD - 1638	● Kırmızı		0,8 x 6,35	6,6	7,5	21,8	10,5	3,8	200	2,00
EFFD - 2288	● Mavi	1,50-2,50 mm ²	0,8 x 2,80	3,2	6,5	20,0	10,5	4,7	200	1,70
EFFD - 2488	● Mavi		0,8 x 4,75	5,0	6,4	20,2	10,5	4,7	200	1,75
EFFD - 2638	● Mavi		0,8 x 6,35	6,6	7,5	22,2	10,5	4,7	200	2,10
EFFD - 5638	● Sarı	4,00 - 6,00 mm ²	0,8 x 6,35	6,6	7,5	24,2	12,5	6,2	100	2,40



Malzeme : Bakır, Kalay Kaplama
 İzolasyon : PVC
 Çalışma Sıcaklığı : Max. 75°C 300 Volt

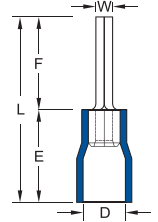

İĞNE TİP İZOLELİ KABLO UÇLARI

Ürün Kodu	Renk	Kablo Kesiti	Ölçüler					Kutu Adedi	B. Fiyat TL / Adet
			W	F	L	B	D		
EVK - 101	● Kırmızı	0,50-1,50 mm ²	1,9	10,0	19,0	10,0	4,0	200	1,50
EVK - 102	● Mavi	1,50-2,50 mm ²	1,9	12,0	21,8	10,0	4,5	200	1,80
EVK - 106	● Sarı	4,00-6,00 mm ²	2,8	14,0	27,0	27,0	6,4	100	4,30



Malzeme : Pirinç, Kalay Kaplama
 İzolasyon : Polyamid
 Çalışma Sıcaklığı : Max. 75°C 300 Volt

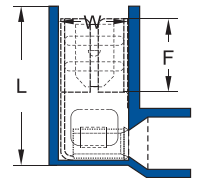

TAM İZOLELİ POLYAMİD BAYRAK TİP TERMİNALLER

Ürün Kodu	Renk	Kablo Kesiti	Soket Geniřlięi	Ölçüler			Kutu Adedi	Kutulu B. Fiyat TL / Adet
				W	F	L		
EPFDEB - 1861	● Kırmızı	0,50-1,50 mm ²	0,8 x 6,35	6,6	7,6	16,0	100	3,70
EPFDEB - 2862	● Mavi	1,50 - 2,50 mm ²	0,8 x 6,35	6,6	7,6	16,0	100	3,70



Malzeme : Piring, Kalay Kaplama
İzolasyon : PVC
Çalışma Sıcaklığı : Max. 75°C 300 Volt

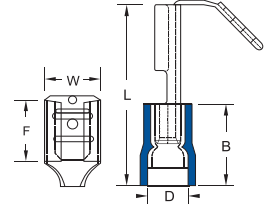

ERKEK / DIŞİ GERİ DÖNÜŞÜMLÜ TERMINALLER

Ürün Kodu	Renk	Kablo Kesiti	Soket Genişliği	Ölçüler					Kutu Adedi	Kutulu B. Fiyat TL / Adet
				W	F	L	B	D		
EFDEG - 1861	● Kırmızı	0,50-1,50 mm ²	0,8 x 6,35	6,6	8,0	22,5	10,5	3,8	100	2,80
EFDEG - 2862	● Mavi	1,50-2,50 mm ²	0,8 x 6,35	6,6	8,0	22,5	10,5	4,7	100	2,90
EFDEG - 5866	● Sarı	4,00-6,00 mm ²	0,8 x 6,35	6,6	8,0	24,0	13,0	6,2	100	3,30



Malzeme : Piring, Kalay Kaplama
İzolasyon : PVC
Çalışma Sıcaklığı : Max. 75°C 300 Volt

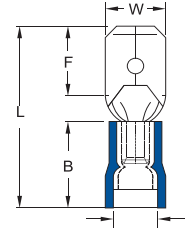

ERKEK FASTON TİP TERMINALLER

Ürün Kodu	Renk	Kablo Kesiti	Soket Genişliği	Ölçüler					Kutu Adedi	Kutulu B. Fiyat TL / Adet
				W	F	L	B	D		
ERV - 1288	● Kırmızı	0,50-1,50 mm ²	0,8 x 2,80	2,8	6,5	19,2	10,5	3,8	200	0,95
ERV - 1488	● Kırmızı		0,8 x 4,75	4,8	6,7	19,8	10,5	3,8	200	1,08
ERV - 1638	● Kırmızı		0,8 x 6,35	6,35	7,7	21,8	10,5	3,8	200	1,38
ERV - 2288	● Mavi	1,50-2,50 mm ²	0,8 x 2,80	2,8	6,7	19,8	10,5	4,7	200	0,95
ERV - 2488	● Mavi		0,8 x 4,75	4,8	6,7	19,8	10,5	4,7	200	1,20
ERV - 2638	● Mavi		0,8 x 6,35	6,35	7,7	21,8	10,5	4,7	200	1,44
ERV - 5638	● Sarı	4,00 - 6,00 mm ²	0,8 x 6,35	6,35	7,7	24,8	13,0	6,2	200	1,70



MONOFAZE - TRİFAZE MÜŞTEREK W OTOMAT BARALARI

SIKMALI KABLO PAPUÇLARI





MONOFAZE MÜŞTEREK W OTOMAT BARALARI

Ürün Kodu	Bakır Kalınlığı	Boy	Modül	Amper	Açıklama	Kutu Adet	Fiyat TL / Adet
ERW-M-18	0,8 mm	53 cm	30	63 A	Monofaze Müşterek W Otomat Bara	50	125,00
ERW-M-19	0,8 mm	106 cm	60	63 A	Monofaze Müşterek W Otomat Bara	50	250,00
ERW-M-20	1 mm	53 cm	30	80 A	Monofaze Müşterek W Otomat Bara	50	150,00
ERW-M-21	1 mm	106 cm	60	80 A	Monofaze Müşterek W Otomat Bara	50	300,00
ERW-M-22	1,5 mm	53 cm	30	100 A	Monofaze Müşterek W Otomat Bara	50	220,00
ERW-M-23	1,5 mm	106 cm	60	100 A	Monofaze Müşterek W Otomat Bara	50	440,00



TRİFAZE MÜŞTEREK W OTOMAT BARALARI

Ürün Kodu	Bakır Kalınlığı	Boy	Modül	Amper	Açıklama	Kutu Adet	Fiyat TL / Adet
ERW-T-28	0,8 mm	53 cm	30	63 A	Trifaze Müşterek W Otomat Bara	25	375,00
ERW-T-29	0,8 mm	106 cm	60	63 A	Trifaze Müşterek W Otomat Bara	25	750,00
ERW-T-30	1 mm	53 cm	30	80 A	Trifaze Müşterek W Otomat Bara	25	460,00
ERW-T-31	1 mm	106 cm	60	80 A	Trifaze Müşterek W Otomat Bara	25	920,00
ERW-T-32	1,5 mm	53 cm	30	100 A	Trifaze Müşterek W Otomat Bara	25	660,00
ERW-T-33	1,5 mm	106 cm	60	100 A	Trifaze Müşterek W Otomat Bara	25	1320,00
ERWTK					Trifaze Bara Kapağı		8,00

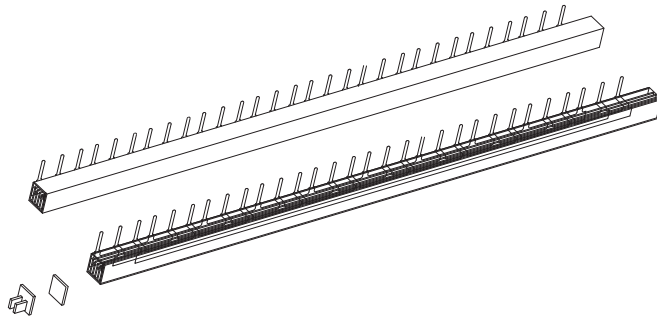

* Ürünlerimiz CE Sertifikalıdır.

* Özel kesim ürünler için lütfen fiyat isteyiniz.

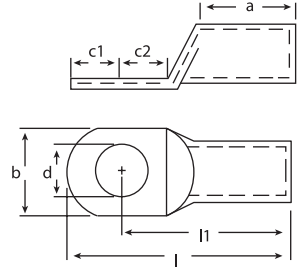

Malzeme : EN13600 standart bakır
Yüzey : Kalay

SIKMALI KABLO PABUÇLARI EKO SERİ

Ürün Kodu	Kablo Kesiti (mm ²)	Delik Çapı	Ölçüler						Kutu Adet	Birim Fiyatı TL / Adet
			d	c1	c2	l	a	b		
SKPE-16-6	16	M6	6.5	7.0	6.5	29.0	12.0	11.0	500	9,00
SKPE-16-8	16	M8	8.5	9.0	8.0	33.0	12.0	13.0	500	9,00
SKPE-25-8	25	M8	8.5	9.3	7.7	39.0	16.0	13.0	350	17,00
SKPE-35-8	35	M8	8.3	9.7	8.3	44.0	19.0	15.5	200	23,00
SKPE-50-10	50	M10	10.5	12.0	12.0	51.5	21.0	17.6	150	32,00
SKPE-70-10	70	M10	10.5	10.0	12.0	54.0	23.0	21.0	100	49,00
SKPE-95-12	95	M12	10.5	12.0	10.0	59.0	26.0	23.5	80	60,00
SKPE-120-12	120	M12	13.0	14.5	13.0	69.0	29.0	27.0	50	82,00
SKPE-150-12	150	M12	13.0	16.5	16.5	76.0	30.0	29.2	40	136,00
SKPE-185-16	185	M16	17.0	18.0	17.0	82.0	33.0	32.3	30	160,00
SKPE-240-16	240	M16	17.0	18.0	17.0	89.0	38.0	37.6	25	236,00

- Ürünlerimiz 3-6 micron arasında kalay kaplamalıdır.
- Kablonun daha rahat girebilmesi için havşalı olarak üretilmektedir.
- Kablo pabuçlarımız ve ek muflarımız EN13600 standardında bakırdan imal edilmektedir.
- Koyu renk ile belirtilen kablo pabuçları standart üretimimizdir. Diğer ölçüler için stok durumu sorunuz.
- Firmamızın önceden haber vermeden ürün ölçülerinde değişiklik yapma hakkı saklıdır.



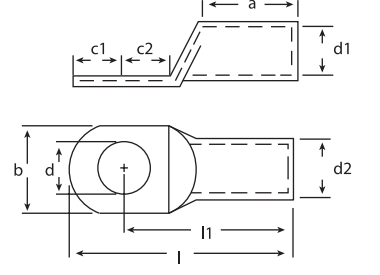

Malzeme : EN13600 standart bakır
Yüzey : Kalay

SIKMALI KABLO PAPUÇLARI STANDART SERİ

Ürün Kodu	Kablo Kesiti (mm ²)	Delik Çapı	Ölçüler									Kutu Adet	Birim Fiyatı TL / Adet
			d	d1	d2	l	l1	a	b	c1	c2		
SKPS-10-6	10	M6	6.5	4.4	6.3	29.0	22.0	12.0	11.0	6.5	7.0	800	9,00
SKPS-10-8		M8	8.5	4.4	6.3	33.0	25.0	12.0	13.5	8.0	9.0	800	9,00
SKPS-16-6	16	M6	6.5	5.5	7.5	29.0	21.0	12.0	11.0	8.0	9.0	500	12,50
SKPS-16-8		M8	8.5	5.5	7.5	33.0	25.0	12.0	13.5	8.0	9.0	500	14,00
SKPS-16-10		M10	10.5	5.5	7.5	33.0	25.0	12.0	16.0	8.0	9.0	500	14,00
SKPS-25-6	25	M6	6.5	7.0	9.5	39.0	31.3	16.0	13.5	7.7	9.3	350	22,00
SKPS-25-8		M8	8.5	7.0	9.5	39.0	31.3	16.0	13.5	7.7	9.3	350	22,00
SKPS-25-10		M10	10.5	7.0	9.5	39.0	31.3	16.0	16.0	7.7	9.3	300	23,00
SKPS-35-6	35	M6	6.5	8.5	11.0	44.0	35.7	19.0	15.5	8.3	9.7	200	31,00
SKPS-35-8		M8	8.5	8.5	11.0	44.0	35.7	19.0	15.5	8.3	9.7	200	31,00
SKPS-35-10		M10	10.5	8.5	11.0	44.0	35.7	19.0	15.5	8.3	9.7	200	33,50
SKPS-50-8	50	M8	8.5	10.0	12.5	51.5	39.5	21.0	19.0	12.0	12.0	150	44,50
SKPS-50-10		M10	10.5	10.0	12.5	51.5	39.5	21.0	19.0	12.0	12.0	150	48,00
SKPS-50-12		M12	13.0	10.0	12.5	50.5	39.5	21.0	19.0	12.0	12.0	150	48,00
SKPS-50-14		M14	15.0	10.0	12.5	51.5	39.5	21.0	21.0	12.0	12.0	150	55,00
SKPS-70-8	70	M8	8.5	11.5	14.5	54.0	42.0	23.0	21.0	12.0	10.0	100	64,00
SKPS-70-10		M10	10.5	11.5	14.5	54.0	42.0	23.0	21.0	12.0	10.0	100	64,00
SKPS-70-12		M12	13.0	11.5	14.5	54.0	42.0	23.0	21.0	12.0	10.0	100	64,00
SKPS-95-8	95	M8	8.5	13.5	16.5	59.0	49.0	26.0	24.5	10.0	12.0	75	79,00
SKPS-95-10		M10	10.5	13.5	16.5	59.0	49.0	26.0	24.5	10.0	12.0	75	79,00
SKPS-95-12		M12	13.0	13.5	16.5	59.0	49.0	26.0	24.5	10.0	12.0	75	79,00
SKPS-120-10	120	M10	10.5	15.5	19.0	69.0	56.0	29.0	28.0	13.0	14.5	50	113,00
SKPS-120-12		M12	13.0	15.5	19.0	69.0	56.0	29.0	28.0	13.0	14.5	50	113,00
SKPS-120-16		M16	17.0	15.5	19.0	69.0	56.0	29.0	28.0	13.0	14.5	50	113,00
SKPS-150-10	150	M10	10.5	16.5	21.0	76.0	60.0	30.0	30.0	16.5	16.5	40	178,00
SKPS-150-12		M12	13.0	16.5	21.0	76.0	60.0	30.0	30.0	16.5	16.5	40	178,00
SKPS-150-16		M16	17.0	16.5	21.0	76.0	60.0	30.0	30.0	16.5	16.5	40	178,00
SKPS-185-12	185	M12	13.0	18.5	23.0	82.5	65.5	33.0	34.0	17.0	18.0	30	220,00
SKPS-185-16		M16	17.0	18.5	23.0	82.5	65.5	33.0	34.0	17.0	18.0	30	220,00
SKPS-240-12	240	M12	13.0	21.0	26.0	89.0	72.0	38.0	38.0	17.0	18.0	25	288,00
SKPS-240-16		M16	17.0	21.0	26.0	89.0	72.0	38.0	38.0	17.0	18.0	25	288,00

**MONTAJ RAYLARI**

Ürün Kodu	Ölçü	Tip	Uzunluk	Kutu Adet	B. Fiyatı TL / Adet
RW-201	35x7,5 mm	Delikli	1 m	20 adet	70,00
RW-202	35x7,5 mm	Delikli	2 m	20 adet	140,00
RW-401	35x15 mm	Delikli	1 m	10 adet	170,00
RW-402	35x15 mm	Delikli	2 m	10 adet	340,00

**RAY TAŞIYICI**

Ürün Kodu	Açıklama	Kutu Adet	B. Fiyatı TL / Adet
ERT	Ray Taşıyıcı	100 Adet	26,00

**RAY TİPİ PANO PRİZLERİ**

Ürün Kodu	Açıklama	Kutu Adet	B. Fiyatı TL / Adet
ERTP	1X16A Raya Montaj Pano İçi Priz	10 Adet	170,00

**AKSİYEL FANLAR**

Ürün Kodu	Açıklama	Kutu Adet	B. Fiyatı \$ / Adet
FAN1	220V AC 120x120x38 Bilezikli Fan Kablolu	1 Adet	11 \$
FAN2	220V AC 172x150x51 Bilezikli Fan Kablolu	1 Adet	35 \$

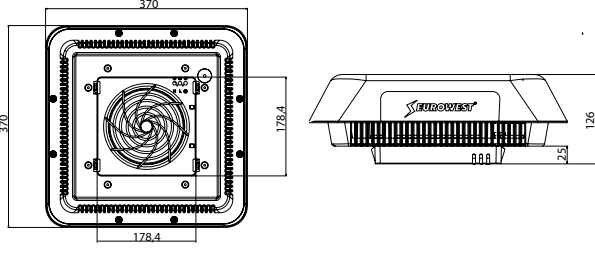

ÇATI FANLARI (HIZLI BAĞLANTILI)

Ürün Kod	Fan Tipi	Besleme	Kapasite m ³ / h	Ambalaj	Birim Fiyat \$ / Adet
EÇF - 4000	172x152x51	220V - 50/60HZ	400	1	70 \$
EÇF - 5500	Ø 190 Radyal	220V - 50/60HZ	560	1	125 \$
EÇF - 6000	Ø 220 Radyal	220V - 50/60HZ	970	1	134 \$



PANO TERMOSTATLARI & HİGROSTAT

Ürün Kodu	Açıklama	Kontakt Tipi	Kutu Adet	B. Fiyatı \$ / Adet
EPT-M	60°C Pano Soğutma İçin Raya Montaj Termostat	1NO	1 Adet	7 \$
EPT-K	60°C Pano Isıtma İçin Raya Montaj Termostat	1NC	1 Adet	7 \$
EHA-90	10 - 95 %RH Nem Ölçer + Hıgrostat	1NO	1 Adet	72 \$



PANO ISITICILAR

Ürün Kodu	Açıklama	Voltaj Aralığı	Kutu Adet	B. Fiyatı \$ / Adet
EPH-15	15W Pano Isıtıcısı	110-250V AC/DC	1 Adet	36 \$
EPH-25	25W Pano Isıtıcısı	110-250V AC/DC	1 Adet	42 \$
EPH-30	30W Pano Isıtıcısı	110-250V AC/DC	1 Adet	47 \$
EPH-50	50W Pano Isıtıcısı	110-250V AC/DC	1 Adet	50 \$
EPH-75	75W Pano Isıtıcısı	110-250V AC/DC	1 Adet	66 \$
EPH-100	100W Pano Isıtıcısı	110-250V AC/DC	1 Adet	75 \$
EPH-150	150W Pano Isıtıcısı	110-250V AC/DC	1 Adet	103 \$

DAĞITICI ÜNİTELER

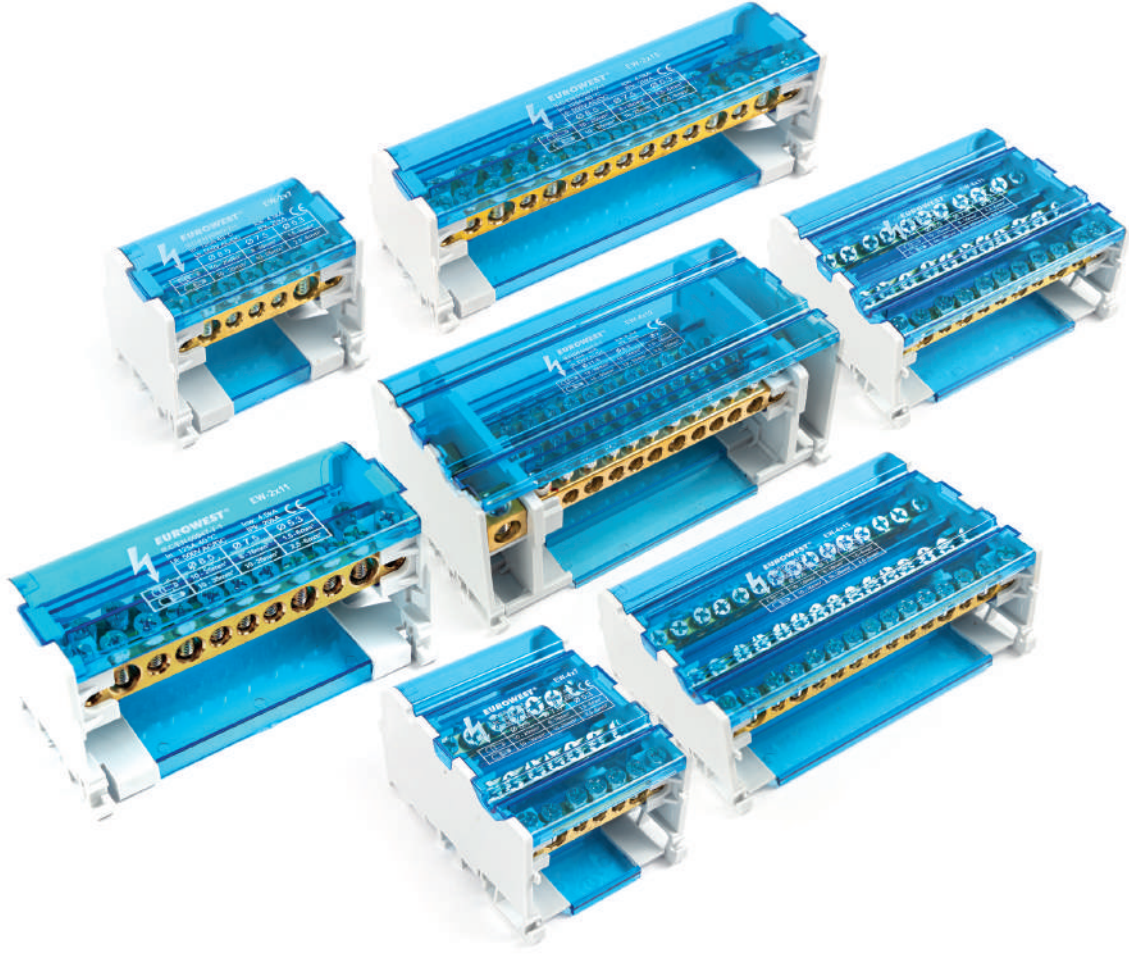

ÇOK AMAÇLI KLEMENSLER



DAĞITICI ÜNİTELER



Ürün Kodu	Kutup Sayısı	Kablo Cinsi	Akım	Kablo Kesiti (mm ²)		Koli Adedi	Fiyat TL / Adet
				Giriş	Çıkış		
EW 2x7	2	Tek Damar ve Çok Telli	125A	1x10-35 mm ²	1x10-25 mm 5x2,5-6 mm	138	225,00

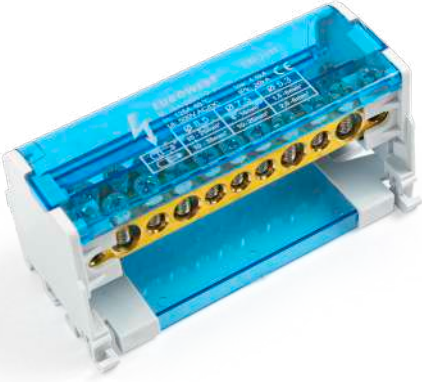

Ürün Kodu	Kutup Sayısı	Kablo Cinsi	Akım	Kablo Kesiti (mm ²)		Koli Adedi	Fiyat TL / Adet
				Giriş	Çıkış		
EW 2x11	2	Tek Damar ve Çok Telli	125A	2x10-35 mm ²	2x10-25 mm 7x2,5-6 mm	84	320,00

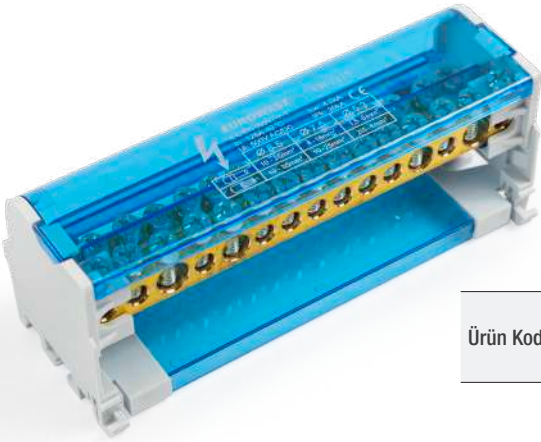

Ürün Kodu	Kutup Sayısı	Kablo Cinsi	Akım	Kablo Kesiti (mm ²)		Koli Adedi	Fiyat TL / Adet
				Giriş	Çıkış		
EW 2x15	2	Tek Damar ve Çok Telli	125A	2x10-35 mm ²	2x10-25 mm 11x2,5-6 mm	72	415,00



Ürün Kodu	Kutup Sayısı	Kablo Cinsi	Akım	Kablo Kesiti (mm ²)		Koli Adedi	Fiyat TL / Adet
				Giriş	Çıkış		
EW 4x7	4	Tek Damar ve Çok Telli	125A	1x10-35 mm ²	1x10-25 mm ² 5x2,5-6 mm ²	74	415,00

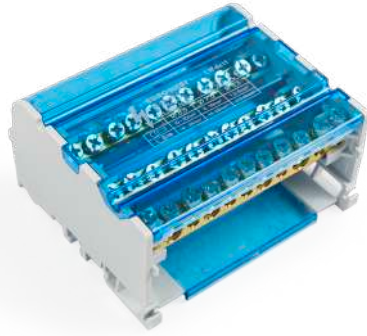

Ürün Kodu	Kutup Sayısı	Kablo Cinsi	Akım	Kablo Kesiti (mm ²)		Koli Adedi	Fiyat TL / Adet
				Giriş	Çıkış		
EW 4x11	4	Tek Damar ve Çok Telli	125A	2x10-35 mm ²	1x10-25 mm ² 7x2,5-6 mm ²	50	620,00

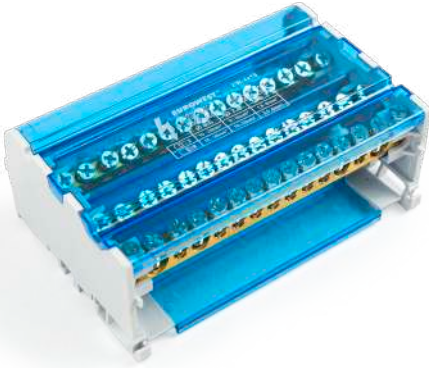

Ürün Kodu	Kutup Sayısı	Kablo Cinsi	Akım	Kablo Kesiti (mm ²)		Koli Adedi	Fiyat TL / Adet
				Giriş	Çıkış		
EW 4x15	4	Tek Damar ve Çok Telli	125A	2x10-35 mm ²	2x10-25 mm ² 11x2,5-6 mm ²	40	770,00



Ürün Kodu	Kutup Sayısı	Kablo Cinsi	Akım	Kablo Kesiti (mm ²)		Koli Adedi	Fiyat TL / Adet
				Giriş	Çıkış		
EW 4x12	4	Tek Damar ve Çok Telli	160A	1x10-50 mm ²	3x10-35 mm ² 8x2,5-16 mm ²	18	1.850,00



Ürün Kodu	Akım	Kablo Kesiti (mm ²)		Paket Adedi	Koli Adedi	Fiyat TL / Adet
		Giriş	Çıkış			
EW-80A	80A	1x10-16 mm ²	4x2,5-6 mm 2x2,5-16 mm	5	200	190,00



Ürün Kodu	Akım	Kablo Kesiti (mm ²)		Paket Adedi	Koli Adedi	Fiyat TL / Adet
		Giriş	Çıkış			
EW-125A	125A	1x10-35 mm ²	6x2,5-16 mm Köprü 1x6-16 mm	5	160	390,00



Ürün Kodu	Akım	Kablo Kesiti (mm ²)		Paket Adedi	Koli Adedi	Fiyat TL / Adet
		Giriş	Çıkış			
EW-160A	160A	1x10-70 mm ²	6x2,5-16 mm Köprü 1x6-16 mm	5	160	395,00



Ürün Kodu	Akım	Kablo Kesiti (mm ²)		Paket Adedi	Koli Adedi	Fiyat TL / Adet
		Giriş	Çıkış			
EW-250A	250A	1x35-120 mm ²	4x2,5-10 mm ² 5x2,5-16 mm ² 2x6-35 mm ²	3	54	1.140,00



Ürün Kodu	Akım	Kablo Kesiti (mm ²)		Paket Adedi	Koli Adedi	Fiyat TL / Adet
		Giriş	Çıkış			
EW-400A	400A	1x95-185 mm ²	4x2,5-10 mm ² 5x2,5-16 mm ² 2x6-35 mm ²	3	54	1.200,00



Ürün Kodu	Akım	Kablo Kesiti (mm ²)		Paket Adedi	Koli Adedi	Fiyat TL / Adet
		Giriş	Çıkış			
EW-500A	500A	8x24 mm ²	4x2,5-10 mm ² 5x2,5-16 mm ² 2x6-35 mm ²	3	54	1.300,00



GEÇMELİ BUAT KLEMENSLER

Ürün Kodu	Renk	Kablo Kesiti	Ölçüler			Ambalaj Adedi		B. Fiyat TL / Adet
			En	Boy	Yükseklik	Paket	Koli	
EW 2,5 - 2	BEYAZ	0,50 - 2,50 mm ²	9.8	16.4	5.8	200	10000	4,50
EW 2,5 - 3	TURUNCU	0,50 - 2,50 mm ²	13.9	16.4	5.8	200	10000	4,70
EW 2,5 - 4	KIRMIZI	0,50 - 2,50 mm ²	17.9	16.4	5.8	100	5000	5,40
EW 2,5 - 5	SARI	0,50 - 2,50 mm ²	21.9	16.4	5.8	100	5000	6,30
EW 2,5 - 6	KIRMIZI	0,50 - 2,50 mm ²	13.8	16.4	11.25	100	5000	7,90
EW 2,5 - 8	GRİ	0,50 - 2,50 mm ²	17.8	16.4	11.25	100	5000	9,00



ÇOK AMAÇLI KLEMENSLER

Ürün Kodu	Kablo Kesiti	Açıklama	Ambalaj Adedi		B. Fiyat TL / Adet
			Paket	Koli	
EW-412	0,14 - 4,0 mm ²	2 İletken Bağlantılı	100	5000	8,00
EW-413	0,14 - 4,0 mm ²	3 İletken Bağlantılı	100	5000	10,70
EW-414	0,14 - 4,0 mm ²	4 İletken Bağlantılı	50	2500	13,00
EW-415	0,14 - 4,0 mm ²	5 İletken Bağlantılı	50	2500	15,60



ISI İLE DARALAN MAKARONLAR

KAPLO TOPLAMA ÇORAPLARI





TEKNİK ÖZELLİKLER

Malzeme : Polyolefin
Daralma Oranı : 2/1
Yanmazlık : Kendi kendine söner.
Çalışma Sıcaklığı : -55°C +125°C

ISI İLE DARALAN SİYAH MAKARONLAR

Ürün Kodu	Ölçüler		Daralmadan Önce mm		Daralmadan Sonra mm		Boy (m)	B. Fiyat \$ / Adet
	İnç	mm	İç Çap	Cidar Kalınlığı	İç Çap	Cidar Kalınlığı		
E-001	1	----	2.0 ± 0.3	0.16 ± 0.05	0.70	0.30 ± 0.05	200	0.10 \$
E-002	1.5	----	2.0 ± 0.3	0.16 ± 0.05	0.80	0.30 ± 0.05	200	0.11 \$
E-003	2	----	2.5 ± 0.3	0.16 ± 0.05	1.00	0.35 ± 0.05	200	0.13 \$
E-004	2.4	3/32	3.0 ± 0.3	0.16 ± 0.05	1.50	0.35 ± 0.05	200	0.13 \$
E-005	2.5	----	3.0 ± 0.3	0.16 ± 0.05	1.25	0.38 ± 0.05	200	0.17 \$
E-006	3	----	3.5 ± 0.4	0.20 ± 0.05	1.50	0.38 ± 0.05	200	0.18 \$
E-007	3.2	1/8	3.5 ± 0.4	0.20 ± 0.05	1.75	0.40 ± 0.05	200	0.18 \$
E-008	3.5	----	4.0 ± 0.4	0.20 ± 0.05	1.75	0.40 ± 0.05	200	0.19 \$
E-009	4	----	4.5 ± 0.4	0.20 ± 0.05	2.00	0.45 ± 0.05	200	0.22 \$
E-010	4.5	----	4.8 ± 0.4	0.20 ± 0.05	2.00	0.47 ± 0.08	100	0.26 \$
E-011	4.8	3/16	5.2 ± 0.4	0.20 ± 0.05	2.60	0.47 ± 0.08	100	0.26 \$
E-012	5	----	5.5 ± 0.4	0.20 ± 0.05	2.50	0.55 ± 0.08	100	0.28 \$
E-013	6	----	6.5 ± 0.4	0.22 ± 0.05	3.00	0.55 ± 0.08	100	0.32 \$
E-014	6.4	1/4	7.0 ± 0.4	0.28 ± 0.05	3.50	0.55 ± 0.08	100	0.32 \$
E-015	7	----	7.5 ± 0.4	0.28 ± 0.05	3.50	0.60 ± 0.08	100	0.39 \$
E-016	8	----	8.5 ± 0.4	0.30 ± 0.08	4.00	0.60 ± 0.08	100	0.39 \$
E-017	9.5	3/8	10.0 ± 0.5	0.30 ± 0.08	5.00	0.60 ± 0.08	100	0.39 \$
E-018	10	----	10.5 ± 0.5	0.30 ± 0.08	5.00	0.60 ± 0.08	100	0.43 \$
E-019	12.7	1/2	13.0 ± 0.5	0.33 ± 0.10	6.50	0.65 ± 0.08	100	0.50 \$
E-020	13	----	13.5 ± 0.5	0.33 ± 0.10	6.50	0.65 ± 0.08	100	0.53 \$
E-021	14	----	14.5 ± 0.5	0.33 ± 0.10	7.00	0.70 ± 0.08	100	0.62 \$
E-022	16	4/5	16.5 ± 0.6	0.35 ± 0.12	8.00	0.75 ± 0.08	100	0.83 \$
E-023	18	----	19.0 ± 0.6	0.40 ± 0.15	9.00	0.80 ± 0.15	100	1.10 \$
E-024	19.1	3/4	20.5 ± 0.6	0.40 ± 0.15	10.00	0.80 ± 0.15	100	1.10 \$
E-025	20	----	20.5 ± 0.6	0.40 ± 0.15	10.00	0.80 ± 0.15	100	1.38 \$
E-026	22	----	22.5 ± 0.7	0.45 ± 0.15	12.00	0.95 ± 0.15	100	1.70 \$
E-027	25.4	1	25.6 ± 0.7	0.45 ± 0.15	12.00	0.95 ± 0.15	50	1.82 \$
E-028	30	----	31.5 ± 0.7	0.50 ± 0.15	15.00	0.95 ± 0.15	50	2.40 \$
E-029	32	1 - 1/4	33.0 ± 0.7	0.50 ± 0.15	16.50	0.95 ± 0.15	50	2.40 \$
E-030	35	----	38.0 ± 0.7	0.50 ± 0.15	16.00	1.00 ± 0.15	50	3.10 \$
E-031	38	1 - 1/2	40.0 ± 0.7	0.50 ± 0.15	20.00	1.00 ± 0.15	50	3.30 \$
E-032	40	----	40.5 ± 0.7	0.50 ± 0.15	20.00	1.00 ± 0.15	50	3.30 \$
E-033	51	2	52.5 ± 0.7	0.50 ± 0.15	25.00	1.00 ± 0.15	25	4.20 \$
E-034	60	----	60.5 ± 0.8	0.52 ± 0.15	30.00	1.00 ± 0.16	25	5.60 \$
E-035	70	----	70.5 ± 1.0	0.55 ± 0.15	40.00	1.10 ± 0.18	25	7.50 \$
E-036	80	----	82.0 ± 1.0	0.55 ± 0.15	40.00	1.10 ± 0.18	25	8.25 \$
E-037	90	----	90.0 ± 1.0	0.55 ± 0.15	45.00	1.10 ± 0.18	25	9.35 \$
E-038	102	4	105.0 ± 1.0	0.55 ± 0.15	51.00	1.10 ± 0.18	25	10.50 \$
E-039	120	----	120.0 ± 1.0	0.55 ± 0.15	60.00	1.10 ± 0.18	25	14.50 \$
E-040	150	----	150.0 ± 1.0	0.55 ± 0.15	76.00	1.10 ± 0.18	25	22.00 \$
E-041	180	----	180.0 ± 1.0	0.55 ± 0.15	90.00	1.10 ± 0.18	25	31.00 \$



KABLO TOPLAMA ÇORAPLARI

Ürün Kodu	Kesit	Açıklama	Rulo Metraj	B. Fiyatı \$ / m
EVC-3	3 mm	Kablo Toplama Çorabı - Siyah	100 m	0,24 \$
EVC-6	6 mm	Kablo Toplama Çorabı - Siyah	100 m	0,29 \$
EVC-8	8 mm	Kablo Toplama Çorabı - Siyah	100 m	0,30 \$
EVC-10	10 mm	Kablo Toplama Çorabı - Siyah	100 m	0,36 \$
EVC-12	12 mm	Kablo Toplama Çorabı - Siyah	100 m	0,43 \$
EVC-15	15 mm	Kablo Toplama Çorabı - Siyah	100 m	0,48 \$
EVC-20	20 mm	Kablo Toplama Çorabı - Siyah	100 m	0,56 \$
EVC-25	25 mm	Kablo Toplama Çorabı - Siyah	100 m	0,72 \$
EVC-30	30 mm	Kablo Toplama Çorabı - Siyah	50 m	0,87 \$
EVC-40	40 mm	Kablo Toplama Çorabı - Siyah	50 m	1,14 \$
EVC-50	50 mm	Kablo Toplama Çorabı - Siyah	25 m	1,40 \$

Çalışma sıcaklığı: -50° - 150°



Ø22 BUTON ve LEDLİ SİNYALLER



YAYLI BUTONLAR

Ürün Kodu	Açıklama	Renk	Kutu Adet	B. Fiyatı TL / Adet
EW-55-10	1NO Start Buton	Yeşil	10	85,00
EW-55-01	1NC Stop Buton	Kırmızı	10	85,00
EW-55-11	1NO Start Buton	Sarı	10	85,00
EW-55-21	1NO Start Buton	Mavi	10	85,00
EW-55-31	1NO Start Buton	Beyaz	10	85,00
EW-55-41	1NO Start Buton	Siyah	10	85,00

**LED IŞIKLI YAYLI BUTONLAR**

Ürün Kodu	Açıklama	Renk	Kutu Adet	B. Fiyatı TL / Adet
EW-55-10L	1NO Start Buton (Led 220V AC-DC)	Yeşil	10	160,00
EW-55-01L	1NC Stop Buton (Led 220V AC-DC)	Kırmızı	10	160,00
EW-55-11L	1NO Start Buton (Led 220V AC-DC)	Sarı	10	160,00
EW-55-21L	1NO Start Buton (Led 220V AC-DC)	Mavi	10	160,00
EW-55-31L	1NO Start Buton (Led 220V AC-DC)	Beyaz	10	160,00
EW-55-10L-110	1NO Start Buton (Led 110V AC-DC)	Yeşil	10	160,00
EW-55-01L-110	1NC Stop Buton (Led 110V AC-DC)	Kırmızı	10	160,00
EW-55-11L-110	1NO Start Buton (Led 110V AC-DC)	Sarı	10	160,00
EW-55-21L-110	1NO Start Buton (Led 110V AC-DC)	Mavi	10	160,00
EW-55-31L-110	1NO Start Buton (Led 110V AC-DC)	Beyaz	10	160,00
EW-55-10L-24	1NO Start Buton (Led 24V AC-DC)	Yeşil	10	160,00
EW-55-01L-24	1NC Stop Buton (Led 24V AC-DC)	Kırmızı	10	160,00
EW-55-11L-24	1NO Start Buton (Led 24V AC-DC)	Sarı	10	160,00
EW-55-21L-24	1NO Start Buton (Led 24V AC-DC)	Mavi	10	160,00
EW-55-31L-24	1NO Start Buton (Led 24V AC-DC)	Beyaz	10	160,00



KALICI MANDAL BUTONLAR

Ürün Kodu	Açıklama	Renk	Kutu Adet	B. Fiyatı TL / Adet
EW-55-10X	1NO Mandal Buton (0-1)	Siyah	10	98,00
EW-55-20XS	2NO Mandal Buton (1-0-2)	Siyah	10	132,00

KAYICI MANDAL BUTONLAR

Ürün Kodu	Açıklama	Renk	Kutu Adet	B. Fiyatı TL / Adet
EW-55-10X/FU	1NO Mandal Buton (0-1)	Siyah	10	105,00
EW-55-20XS/FU	2NO Mandal Buton (1-0-2)	Siyah	10	140,00

KALICI - KAYICI MANDAL BUTON

Ürün Kodu	Açıklama	Renk	Kutu Adet	B. Fiyatı TL / Adet
EW-55-20XS/F	2NO Mandal Buton Sağ Pozisyon Kalıcı (1-0-2) Sol Pozisyon Kayıcı	Siyah	10	145,00



LED IŞIKLI KALICI MANDAL BUTONLAR

Ürün Kodu	Açıklama	Renk	Kutu Adet	B. Fiyatı TL / Adet
EW-55-10XL	1NO Mandal Buton (0-1) 220V AC-DC	Yeşil	10	160,00
EW-55-01XL	1NC Mandal Buton (0-1) 220V AC-DC	Kırmızı	10	160,00
EW-55-11XL	1NO Mandal Buton (0-1) 220V AC-DC	Sarı	10	160,00
EW-55-10XL-24	1NO Mandal Buton (0-1) 24V AC-DC	Yeşil	10	160,00
EW-55-01XL-24	1NC Mandal Buton (0-1) 24V AC-DC	Kırmızı	10	160,00
EW-55-11XL-24	1NO Mandal Buton (0-1) 24V AC-DC	Sarı	10	160,00
EW-55-10XL-110	1NO Mandal Buton (0-1) 110V AC-DC	Yeşil	10	160,00
EW-55-01XL-110	1NC Mandal Buton (0-1) 110V AC-DC	Kırmızı	10	160,00
EW-55-11XL-110	1NO Mandal Buton (0-1) 110V AC-DC	Sarı	10	160,00
EW-55-20XSL	2NO Mandal Buton (1-0-2) 220V AC-DC	Yeşil	10	195,00
EW-55-02XSL	2NC Mandal Buton (1-0-2) 220V AC-DC	Kırmızı	10	195,00
EW-55-21XSL	2NO Mandal Buton (1-0-2) 220V AC-DC	Sarı	10	195,00
EW-55-20XSL-24	2NO Mandal Buton (1-0-2) 24V AC-DC	Yeşil	10	195,00
EW-55-02XSL-24	2NC Mandal Buton (1-0-2) 24V AC-DC	Kırmızı	10	195,00
EW-55-21XSL-24	2NO Mandal Buton (1-0-2) 24V AC-DC	Sarı	10	195,00
EW-55-20XSL-110	2NO Mandal Buton (1-0-2) 110V AC-DC	Yeşil	10	195,00
EW-55-02XSL-110	2NC Mandal Buton (1-0-2) 110V AC-DC	Kırmızı	10	195,00
EW-55-21XSL-110	2NO Mandal Buton (1-0-2) 110V AC-DC	Sarı	10	195,00



ANAHTARLI KALICI BUTONLAR

Ürün Kodu	Açıklama	Renk	Kutu Adet	B. Fiyatı TL / Adet
EW-55-10Y	1NO Anahtarlđ Buton (0-1)	Siyah	10	145,00
EW-55-20YL	2NO Anahtarlđ Buton (1-0-2)	Siyah	10	180,00

**Ø40 mm KAYICI MANTAR BUTONLAR**

Ürün Kodu	Açıklama	Renk	Kutu Adet	B. Fiyatı TL / Adet
EW-55-01M	1NC Stop Mantar Buton	Kırmızı	10	100,00

**Ø40 mm KALICI (ACİL STOP) MANTAR BUTONLAR**

Ürün Kodu	Açıklama	Renk	Kutu Adet	B. Fiyatı TL / Adet
EW-55-01ZS	1NC Stop Mantar Buton	Kırmızı	10	113,00



Ø40 mm KALICI LEDLİ (ACİL STOP) MANTAR BUTONLAR

Ürün Kodu	Açıklama	Renk	Kutu Adet	B. Fiyatı TL / Adet
EW-55-01ZFD	1NC Led Işıklı Stop Mantar Buton (220V AC)	Kırmızı	10	300,00
EW-55-01ZFD-24	1NC Led Işıklı Stop Mantar Buton (24V AC-DC)	Kırmızı	10	300,00
EW-55-01ZFD-110	1NC Led Işıklı Stop Mantar Buton (110V AC-DC)	Kırmızı	10	300,00

**Ø40 mm KALICI MANTAR BUTONLAR**

Ürün Kodu	Açıklama	Renk	Kutu Adet	B. Fiyatı TL / Adet
EW2-ES542	1NC Mantar Buton	Kırmızı	20	100,00
EW2-E142	1NC Mantar Buton Anahtarlı	Kırmızı	10	165,00

**İKİZ BUTONLAR**

Ürün Kodu	Açıklama	Renk	Kutu Adet	B. Fiyatı TL / Adet
EW-55-11R	1NC+1NO İkiz Buton	Kırmızı-Yeşil	10	162,00
EW-55-11RL-24	1NC+1NO Led Işıklı İkiz Buton (24V AC-DC)	Kırmızı-Yeşil	10	220,00
EW-55-11RL-110	1NC+1NO Led Işıklı İkiz Buton (110V AC-DC)	Kırmızı-Yeşil	10	220,00
EW-55-11RL	1NC+1NO Led Işıklı İkiz Buton (220V AC)	Kırmızı-Yeşil	10	220,00



Ø22 mm LED'Lİ SİNYALLER

Ürün Kodu	Açıklama	Renk	Kutu Adet	B. Fiyatı TL / Adet
LS-220V-K	Ø 22 mm Led 220V AC-DC	Kırmızı	10	32,00
LS-220V-Y	Ø 22 mm Led 220V AC-DC	Yeşil	10	32,00
LS-220V-S	Ø 22 mm Led 220V AC-DC	Sarı	10	32,00
LS-220V-M	Ø 22 mm Led 220V AC-DC	Mavi	10	32,00
LS-220V-B	Ø 22 mm Led 220V AC-DC	Beyaz	10	38,00
LS-110V-K	Ø 22 mm Led 110V AC-DC	Kırmızı	10	32,00
LS-110V-Y	Ø 22 mm Led 110V AC-DC	Yeşil	10	32,00
LS-110V-S	Ø 22 mm Led 110V AC-DC	Sarı	10	32,00
LS-110V-M	Ø 22 mm Led 110V AC-DC	Mavi	10	32,00
LS-110V-B	Ø 22 mm Led 110V AC-DC	Beyaz	10	38,00
LS-24V-K	Ø 22 mm Led 24V AC-DC	Kırmızı	10	32,00
LS-24V-Y	Ø 22 mm Led 24V AC-DC	Yeşil	10	32,00
LS-24V-S	Ø 22 mm Led 24V AC-DC	Sarı	10	32,00
LS-24V-M	Ø 22 mm Led 24V AC-DC	Mavi	10	32,00
LS-24V-B	Ø 22 mm Led 24V AC-DC	Beyaz	10	38,00



EA9S LED AMPULLER

Ürün Kodu	Açıklama	Renk	Kutu Adet	B. Fiyatı TL / Adet
EA9S-K	BA9S Led Ampul 220V AC-DC	Kırmızı	50	38,00
EA9S-Y	BA9S Led Ampul 220V AC-DC	Yeşil	50	38,00
EA9S-S	BA9S Led Ampul 220V AC-DC	Sarı	50	38,00
EA9S-M	BA9S Led Ampul 220V AC-DC	Mavi	50	38,00
EA9S-B	BA9S Led Ampul 220V AC-DC	Beyaz	50	46,00
EA9S-K	BA9S Led Ampul 110V AC-DC	Kırmızı	50	38,00
EA9S-Y	BA9S Led Ampul 110V AC-DC	Yeşil	50	38,00
EA9S-S	BA9S Led Ampul 110V AC-DC	Sarı	50	38,00
EA9S-M	BA9S Led Ampul 110V AC-DC	Mavi	50	38,00
EA9S-B	BA9S Led Ampul 110V AC-DC	Beyaz	50	46,00
EA9S-K	BA9S Led Ampul 24V AC-DC	Kırmızı	50	38,00
EA9S-Y	BA9S Led Ampul 24V AC-DC	Yeşil	50	38,00
EA9S-S	BA9S Led Ampul 24V AC-DC	Sarı	50	38,00
EA9S-M	BA9S Led Ampul 24V AC-DC	Mavi	50	38,00
EA9S-B	BA9S Led Ampul 24V AC-DC	Beyaz	50	46,00



Ø22 mm LED'Lİ VOLTMETRE

Ürün Kodu	Açıklama	Renk	Kutu Adet	B. Fiyatı TL / Adet
EW16-22LV-K	Ø 22 mm Led 24-450V Voltmetre	Kırmızı	10	120,00
EW16-22LV-Y	Ø 22 mm Led 24-450V Voltmetre	Yeşil	10	120,00
EW16-22LV-S	Ø 22 mm Led 24-450V Voltmetre	Sarı	10	120,00
EW16-22LV-M	Ø 22 mm Led 24-450V Voltmetre	Mavi	10	120,00
EW16-22LV-B	Ø 22 mm Led 24-450V Voltmetre	Beyaz	10	120,00

**Ø22 mm LED'Lİ AMPERMETRE**

Ürün Kodu	Açıklama	Renk	Kutu Adet	B. Fiyatı TL / Adet
EW16-22LA-K	Ø 22 mm Led 100A Ampermetre	Kırmızı	5	240,00
EW16-22LA-Y	Ø 22 mm Led 100A Ampermetre	Yeşil	5	240,00
EW16-22LA-S	Ø 22 mm Led 100A Ampermetre	Sarı	5	240,00
EW16-22LA-M	Ø 22 mm Led 100A Ampermetre	Mavi	5	240,00
EW16-22LA-B	Ø 22 mm Led 100A Ampermetre	Beyaz	5	240,00

**Ø22 mm LED'Lİ VOLTMETRE & AMPERMETRE**

Ürün Kodu	Açıklama	Renk	Kutu Adet	B. Fiyatı TL / Adet
EW16-22LVA-K	Ø 22 mm Led 24-450V Voltmetre Ampermetre	Kırmızı	5	510,00
EW16-22LVA-Y	Ø 22 mm Led 24-450V Voltmetre Ampermetre	Yeşil	5	510,00
EW16-22LVA-S	Ø 22 mm Led 24-450V Voltmetre Ampermetre	Sarı	5	510,00
EW16-22LVA-M	Ø 22 mm Led 24-450V Voltmetre Ampermetre	Mavi	5	510,00
EW16-22LVA-B	Ø 22 mm Led 24-450V Voltmetre Ampermetre	Beyaz	5	510,00



Ø22 mm LED'Lİ BUZZER (90dB)

Ürün Kodu	Açıklama	Renk	Kutu Adet	B. Fiyatı TL / Adet
22DS/MS	Ø 22 mm Sesli Led Flaşör İkazlı 220V AC-DC	Kırmızı	10	130,00
22DS/MS24	Ø 22 mm Sesli Led Flaşör İkazlı 24V AC-DC	Kırmızı	10	130,00



MOTORLU SİRENLER

Ürün Kodu	Açıklama	Renk	Kutu Adet	B. Fiyatı TL / Adet
MS - 190-220	75 mm Metal Gövde 220V AC (110-130dB)	Kırmızı	1	530,00
MS - 190-24	75 mm Metal Gövde 24V DC (110-130dB)	Kırmızı	1	530,00



Ø22 mm POTANSİYOMETRE TEK TURLU

Ürün Kodu	Açıklama	Voltaj	Kutu Adet	B. Fiyatı TL / Adet
EWT22-5K	22 mm potansiyometre 5K	220 V AC	10	190,00
EWT22-10K	22 mm potansiyometre 10K	220 V AC	10	190,00



BUTON AKSESUARLARI

Ürün Kodu	Açıklama	Kutu Adet	B. Fiyatı TL / Adet
E-10	Yedek 1NO Start Kontak	50	35,00
E-01	Yedek 1NC Stop Kontak	50	35,00
EBK	Buton Koruma Kapağı	1	71,00
EC	Plastik Buton Rozeti	60	5,00
ED/60	60 mm Acil Stop Etiketi	100	14,30

**BOŞ VE MONTAJLI KUMANDA KUTULARI**

Ürün Kodu	Açıklama	Kutu Adet	B. Fiyatı TL / Adet
EW1-ES542	Acil Stop 40 mm 1 Nc Kalıcı Mantar Acil Buton Kutulu	4	148,00
EW1-ES543	Acil Stop 40 mm 1 Nc Kalıcı Mantar Acil Buton Koruma Kutulu	4	185,00
EWBOX-1K	1'li Boş Buton Kutusu Korumalı	1	72,00
EWBOX-1	1'li Boş Buton Kutusu	1	58,00
EWBOX-2	2'li Boş Buton Kutusu	1	72,00
EWBOX-3	3'li Boş Buton Kutusu	1	93,00
EWBOX-4	4'li Boş Buton Kutusu	1	117,00



VİNÇ KUMANDA BUTONLARI (IP67)

Ürün Kodu	Açıklama	Kutu Adet	B. Fiyatı \$ / Adet
EVK-2	Tek Hızlı 2'li Vinç Kumanda Mekanik Kilitli 5A	1	5,80 \$
EVK-4	Tek Hızlı 4'lü Vinç Kumanda Mekanik Kilitli 5A	1	7,50 \$
EVK-6	Tek Hızlı 6'lı Vinç Kumanda Mekanik Kilitli 5A	1	10,00 \$
EVK-8	Tek Hızlı 8'li Vinç Kumanda Mekanik Kilitli 5A	1	13,00 \$



VİNÇ KUMANDA BUTONLARI (IP67)

Ürün Kodu	Açıklama	Kutu Adet	B. Fiyatı \$ / Adet
EVKB-3	Tek Hızlı 2+Acil Stop Vinç Kumanda Mekanik Kilitli 16A	1	23,00 \$
EVKB-5	Tek Hızlı 4+Acil Stop Vinç Kumanda Mekanik Kilitli 16A	1	32,00 \$
EVKB-7	Tek Hızlı 6+Acil Stop Vinç Kumanda Mekanik Kilitli 16A	1	41,00 \$
EVKB-9	Tek Hızlı 8+Acil Stop Vinç Kumanda Mekanik Kilitli 16A	1	50,00 \$



AYAK PEDALLARI

Ürün Kodu	Açıklama	Kutu Adet	B. Fiyatı \$ / Adet
EAP-1	Kablolu 1NO+1NC Metal Pedal	1	8,50 \$
EAP-2	Kablolu 1NO+1NC Döküm Pedal	1	12,00 \$
EAP-3	Kablolu 1NO+1NC Döküm Pedal	1	15,50 \$
EAP-9	1NO+1NC Döküm Korumalı Kapaklı Pedal	1	38,50 \$

**T5 ANAHTARLI LED ARMATÜR**

Ürün Kodu	Açıklama	Kutu Adet	B. Fiyatı \$ / Adet
EWLAR	5W Anahtarlı Led Armatür	30	6,50 \$



ERİYEN BANTLAR

Ürün Kodu	Açıklama	Kutu Adet	B. Fiyatı \$ / Adet
EVN-1401	19 mm x 0.8 mm x 8m	60	3,85 \$
EVN-1402	50 mm x 0.8 mm x 8m	24	12,00 \$



KABLO İŞARETLEME SİSTEMLERİ

Ürün Kodu	Kesit	Makara	B. Fiyatı TL / Adet
EC 0	0.50 - 1 mm Kablolar İçin	1000	170,00
EC 1	1.50 - 6 mm Kablolar İçin	1000	170,00
EC 2	4 - 16 mm Kablolar İçin	500	170,00
EC 3	10 - 25 mm Kablolar İçin	350	170,00



Sarı Zemin Üzerine Siyah Baskı													
A B C D E F G H I J K L M N O P Q R S T U V W X Y Z + -													
0	1	2	3	4	5	6	7	8	9				

PLASTİK GÖVDELİ LİMİT SWITCHLER**MİKRO SWITCHLER**

PLASTİK GÖVDELİ LİMİT SWITCHLER



Birim Fiyat \$ / Adet	7,00 \$
Ürün Kodu	ELS - 101 (XCK-P100)
Kutu Adet	10
Kontakt Tipi	1NO + 1NC
Açıklama	Doğrusal Hareketli Metal Pim



Birim Fiyat \$ / Adet	7,00 \$
Ürün Kodu	ELS - 103 (XCK-P102)
Kutu Adet	10
Kontakt Tipi	1NO + 1NC
Açıklama	Doğrusal Hareketli 11 mm Metal Makaralı Pim



Birim Fiyat \$ / Adet	7,30 \$
Ürün Kodu	ELS - 131 (XCK-P145)
Kutu Adet	10
Kontakt Tipi	1NO + 1NC
Açıklama	Açısal Hareketli Ayarlanabilir 18 mm Metal Makaralı Döner Kol

PLASTİK GÖVDELİ LİMİT SWITCHLER

Birim Fiyat \$ / Adet	7,00 \$
Ürün Kodu	ELS - 111 (XCK-P121)
Kutu Adet	10
Kontakt Tipi	1NO + 1NC
Açıklama	Açısal Hareketli 14 mm Metal Makralı Kol



Birim Fiyat \$ / Adet	7,00 \$
Ürün Kodu	ELS - 121 (XCK-P118)
Kutu Adet	10
Kontakt Tipi	1NO + 1NC
Açıklama	Açısal Hareketli Ters Açılı 18 mm Metal Makralı Döner Kol



Birim Fiyat \$ / Adet	7,00 \$
Ürün Kodu	ELS - 127 (XCK-P127)
Kutu Adet	10
Kontakt Tipi	1NO + 1NC
Açıklama	Açısal Hareketli Ters Açılı 14 mm Metal Makralı Kol

PLASTİK GÖVDELİ LİMİT SWITCHLER

Birim Fiyat \$ / Adet	7,30 \$
Ürün Kodu	ELS - 191 (XCK-P149)
Kutu Adet	10
Kontakt Tipi	1NO + 1NC
Açıklama	Açısal Hareketli Ayarlanabilir 50 mm Lastik Makaralı Döner Kol



Birim Fiyat \$ / Adet	9,30 \$
Ürün Kodu	ELS - 191 R (XCK-P191R)
Kutu Adet	10
Kontakt Tipi	1NO + 1NC
Açıklama	Açısal Hareketli Ayarlanabilir 50 mm Lastik Makaralı Resetli Döner Kol

PLASTİK GÖVDELİ LİMİT SWITCHLER

Birim Fiyat \$ / Adet	7,30 \$
Ürün Kodu	ELS - 161 (XCK-P161)
Kutu Adet	10
Kontakt Tipi	1NO + 1NC
Açıklama	Açısal Hareketli Spiral Telli Çok Yönlü Kol



Birim Fiyat \$ / Adet	7,30 \$
Ürün Kodu	ELS - 171 (XCK-P171)
Kutu Adet	10
Kontakt Tipi	1NO + 1NC
Açıklama	Açısal Hareketli Metal Uçlu Metal Spiral Çok Yönlü Kol

MİKRO SWITCHLER



Birim Fiyat \$ / Adet	3.80 \$
Ürün Kodu	EW - 1300 (Z-15 G-B)
Amper	15 A
Kutu Adet	20
Kontakt Tipi	1NO + 1NC
Açıklama	Küçük Pimli Switch



Birim Fiyat \$ / Adet	4,20 \$
Ürün Kodu	EW - 1306 (Z-15GD-B)
Amper	15 A
Kutu Adet	20
Kontakt Tipi	1NO + 1NC
Açıklama	Kısa Pimli Switch



Birim Fiyat \$ / Adet	4,90 \$
Ürün Kodu	EW - 1305 (Z-15 GS-B)
Amper	15 A
Kutu Adet	20
Kontakt Tipi	1NO + 1NC
Açıklama	Uzun Pimli Switch



Birim Fiyat \$ / Adet	4,20 \$
Ürün Kodu	EW - 1301 (Z-15 GL-B)
Amper	15 A
Kutu Adet	20
Kontakt Tipi	1NO + NC
Açıklama	Uzun Palet Switch

MİKRO SWITCHLER

Birim Fiyat \$ / Adet	4.50 \$
Ürün Kodu	EW - 1703 (Z-15 GW2-B)
Amper	15 A
Kutu Adet	20
Kontakt Tipi	1NO + NC
Açıklama	Uzun Palet Metal Makaralı Switch



Birim Fiyat \$ / Adet	4,15 \$
Ürün Kodu	EW - 1702 (Z-15 GW21-B)
Amper	15 A
Kutu Adet	20
Kontakt Tipi	1NO + NC
Açıklama	Kısa Palet Switch



Birim Fiyat \$ / Adet	4.50 \$
Ürün Kodu	EW - 1704 (Z-15 GW22-B)
Amper	15 A
Kutu Adet	20
Kontakt Tipi	1NO + 1NC
Açıklama	Kısa Metal Makaralı Switch



Birim Fiyat \$ / Adet	5,00 \$
Ürün Kodu	EW - 1743 (Z-15GW2277-B)
Amper	15 A
Kutu Adet	20
Kontakt Tipi	1NO + 1NC
Açıklama	Tek Yönlü Makaralı Switch

MİKRO SWITCHLER



Birim Fiyat \$ / Adet	5,50 \$
Ürün Kodu	EW - 1307 (Z-15GQ-B)
Amper	15 A
Kutu Adet	20
Kontakt Tipi	1NO + NC
Açıklama	Uzun Pimli Switch



Birim Fiyat \$ / Adet	6,30 \$
Ürün Kodu	EW - 1308 (Z-15GQ22-B)
Amper	15 A
Kutu Adet	20
Kontakt Tipi	1NO + NC
Açıklama	Dikey Metal Makaralı Switch



Birim Fiyat \$ / Adet	4,50 \$
Ürün Kodu	EW - 1705 (Z-15-HW78-B)
Amper	15 A
Kutu Adet	20
Kontakt Tipi	1NO + NC
Açıklama	Uzun Tel Palet Switch

MİKRO SWITCHLER

Birim Fiyat \$ / Adet	6,30 \$
Ürün Kodu	EW - 1309 (Z-15GQ21-B)
Amper	15 A
Kutu Adet	20
Kontakt Tipi	1NO + NC
Açıklama	Yan Dik Metal Makaralı Switch



Birim Fiyat \$ / Adet	0,70 \$
Ürün Kodu	EWP-Y
Kutu Adet	100
Açıklama	Mini Switch Koruma Kılıfı 45° Açılı Kauçuk

MİNİ KAPI SWITCHLERİ

Birim Fiyat TL / Adet	50,00 TL
Ürün Kodu	EKS - 10
Kutu Adet	100
Kontakt Tipi	1NO
Açıklama	Açık Kontakt Kapı Switch



Birim Fiyat TL / Adet	55,00 TL
Ürün Kodu	EKS - 01
Kutu Adet	100
Kontakt Tipi	1NC
Açıklama	Kapalı Kontakt Kapı Switch

MEKANİK VE HİDROLİK EL ALETLERİ



YÜKSÜK SIKMA PENSELERİ

Birim Fiyat \$ / Adet	110,00 \$
Ürün Kodu	VSC8 6-4C
Açıklama	0,08-10 mm ² Yüksük Sıkma Pensesi 4 Köşe



Birim Fiyat \$ / Adet	125,00 \$
Ürün Kodu	VSC8 6-6A
Açıklama	0,08-6 mm ² Yüksük Sıkma Pensesi 6 Köşe



Birim Fiyat \$ / Adet	215,00 \$
Ürün Kodu	VSC11 16-4A
Açıklama	0,08-16 mm ² Yüksük Sıkma Pensesi 4 Köşe



Birim Fiyat \$ / Adet	330,00 \$
Ürün Kodu	VSC12 16-6A
Açıklama	0,08-16 mm ² Yüksük Sıkma Pensesi 6 Köşe



Birim Fiyat \$ / Adet	210,00 \$
Ürün Kodu	VSC10 16-4A
Açıklama	0,08-16 mm ² Yüksük Sıkma Pensesi 4 Köşe



Birim Fiyat \$ / Adet	110,00 \$
Ürün Kodu	VSN-10 WF
Açıklama	0,25-10 mm ² Yüksük Sıkma Pensesi

IZOLELİ VE IZOLESİZ KABLO PAPUCU SIKMA PENSESİ

Birim Fiyat \$ / Adet	105,00 \$
Ürün Kodu	VSN - 30J
Açıklama	0,5-6 mm ² İzoleli Kablo Ucu Sıkma Pensesi

KABLO SIYIRMA PENSESİ



Birim Fiyat \$ / Adet	36,00 \$
Ürün Kodu	HS700D
Açıklama	0,50-6 mm ² Kablo Siyirma Pensesi

KABLO PABUCU SIKMA PENSELERİ



Birim Fiyat \$ / Adet	220,00 \$
Ürün Kodu	VSQ-70SC
Açıklama	6-70 mm ² SKP Sıkma Pensesi



Birim Fiyat \$ / Adet	330,00 \$
Ürün Kodu	VSQ-120B
Açıklama	10-120 mm ² SKP Sıkma Pensesi



Birim Fiyat \$ / Adet	360,00 \$
Ürün Kodu	VSQ - 150SC
Açıklama	25-150 mm ² SKP Sıkma Pensesi

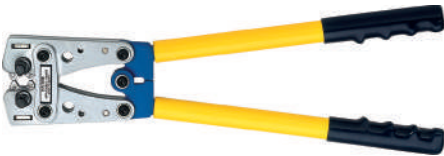

Birim Fiyat \$ / Adet	95,00 \$
Ürün Kodu	HX - 50SC
Açıklama	6-50 mm ² SKP Sıkma Pensesi



Birim Fiyat \$ / Adet	190,00 \$
Ürün Kodu	HX - 120SC
Açıklama	10 - 120 mm ² SKP Sıkma Pensesi

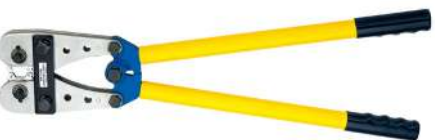

Birim Fiyat \$ / Adet	200,00 \$
Ürün Kodu	HX - 150SC
Açıklama	25 - 150 SKP Sıkma Pensesi

HİDROLİK KABLO PABUCU SIKMA PENSESİ

Birim Fiyat \$ / Adet	160,00 \$
Ürün Kodu	YQK-300
Açıklama	16 - 300 mm ² Hidrolikli SKP Sıkma Pensesi (Çantalı Set)

KABLO KESME MAKASLARI

Birim Fiyat \$ / Adet	33,00 \$
Ürün Kodu	LK-22
Açıklama	25 mm ² Kablo Kesme Makası



Birim Fiyat \$ / Adet	42,00 \$
Ürün Kodu	LK - 38
Açıklama	50 mm ² Kablo Kesme Makası



Birim Fiyat \$ / Adet	45,00 \$
Ürün Kodu	LK - 60
Açıklama	60 mm ² Kablo Kesme Makası



Birim Fiyat \$ / Adet	76,00 \$
Ürün Kodu	HJ - 130
Açıklama	120 mm ² Kablo Kesme Makası



Birim Fiyat \$ / Adet	138,00 \$
Ürün Kodu	VC - 150 G
Açıklama	150 mm ² Kablo Kesme Makası



Birim Fiyat \$ / Adet	145,00 \$
Ürün Kodu	VC - 300 G
Açıklama	250 mm ² Kablo Kesme Makası



Birim Fiyat \$ / Adet	210,00 \$
Ürün Kodu	VC - 500 G
Açıklama	500 mm ² Kablo Kesme Makası



10x38 KARTUŞ SİGORTA YUVASI

Ürün Kodu	Ürün Açıklaması	Ambalaj	Birim Fiyat \$ / Adet
RT 18-32 - 1P	10x38A Kartuş Sigorta Yuvası	12	3,75 \$













10x38 PORSELEN SİGORTALAR

Ürün Kodu	Ürün Açıklaması	Ambalaj	Birim Fiyat \$ / Adet
FUSE 2	10x38 2A Porselen Sigorta	10	1,00 \$
FUSE 6	10x38 6A Porselen Sigorta	10	1,00 \$
FUSE 10	10x38 10A Porselen Sigorta	10	1,00 \$
FUSE 16	10x38 16A Porselen Sigorta	10	1,00 \$
FUSE 25	10x38 25A Porselen Sigorta	10	1,00 \$
FUSE 32	10x38 32A Porselen Sigorta	10	1,00 \$



KABLO RAKORLARI

Polyamid Kablo Rakoru (Somunlu) IP68

Kod	Diş Ölçü	Kablo Çapı	Ambalaj (Adet)	Fiyat (TL / Adet)
EPO-01	PG-7	3,0-6,5	500	
EPO-02	PG-9	4,0-8,0	300	
EPO-03	PG-11	5,0-10,0	200	
EPO-04	PG-13,5	6,0-12,0	150	
EPO-05	PG-16	10,0-14,0	125	
EPO-06	PG-21	13,0-18,0	75	
EPO-07	PG-29	18,0-25,0	40	
EPO-08	PG-36	22,0-32,0	20	
EPO-09	PG-42	30,0-38,0	10	
EPO-10	PG-48	34,0-44,0	8	



EUROWEST[®]

Creating Best Value

 **ELIZANELEKTRİK**

Satış Grubu:

Doğu / Güney Doğu Bölge : 0542 279 46 42

Karadeniz Bölge : 0552 897 46 48

İç Anadolu / Ege Bölge : 0530 179 46 43

Merkez: İvedik OSB Melih Gökçek Blv.

Elektrokent-2 İş Merkezi No: 83/16

Yenimahalle / ANKARA

İmalat: İvedik OSB 1443 Sok. No: 13

Yenimahalle / ANKARA

GSM : 0530 179 46 43

Tel : 0312 394 47 71 Faks: 0312 394 47 91

info@eurowest.com.tr

info@elizanelektrik.com.tr

www.elizanelektrik.com.tr

www.eurowest.com.tr



instagram



katalog